

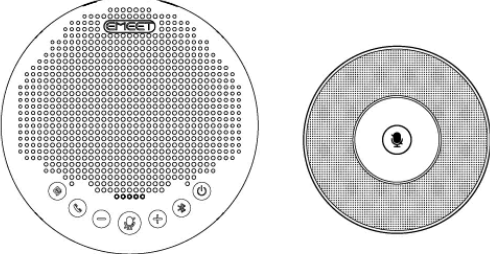





include a wireless USB adapter, A350, 1 C-C adapter, 1 C-C USB data cable, as well as 1 user manual and 1 safety declaration.

## Luna Plus Meeting Kit

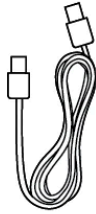





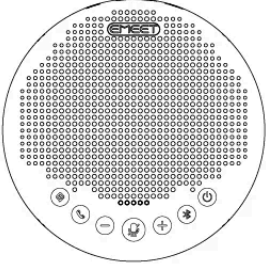

			
		x 1	
			
x 1	x 1	x 1	x 2

The Luna Plus package includes 1 Luna Plus. Accessories include a wireless USB adapter A350,, 1 C-C USB data cable, 1 C-A adapter, as well as 1 user manual and 1 safety declaration.

## Luna Plus



			
		x 1	
			
x 1	x 1	x 1	x 1

### Device display

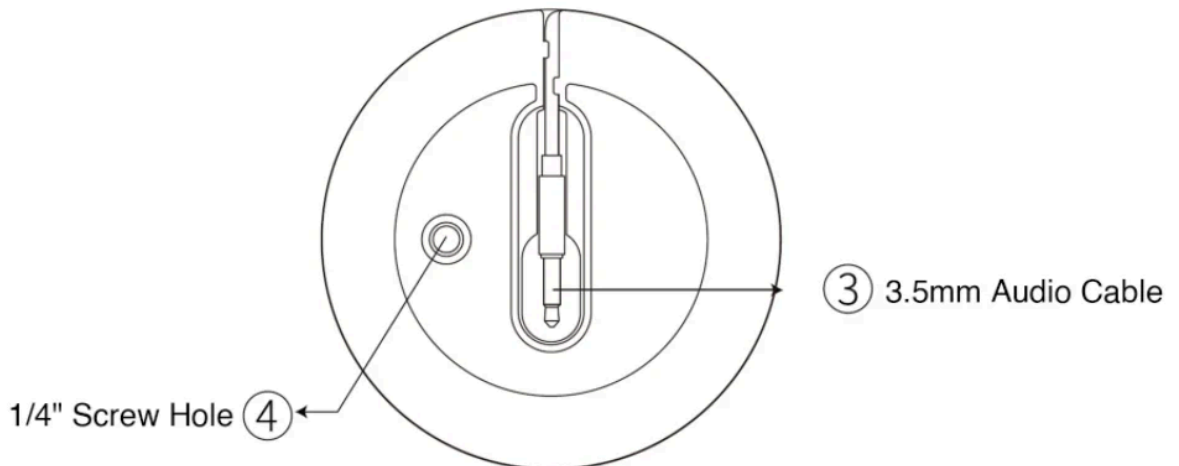
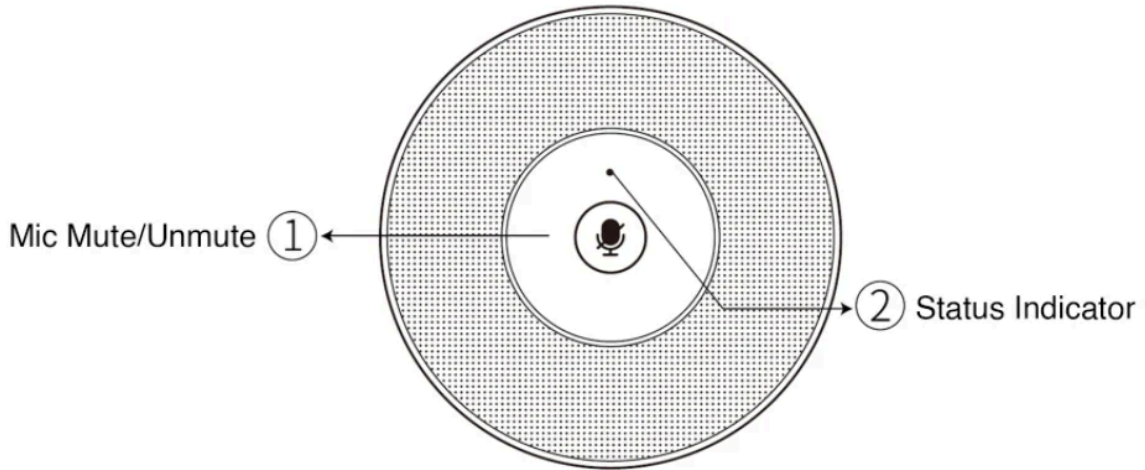
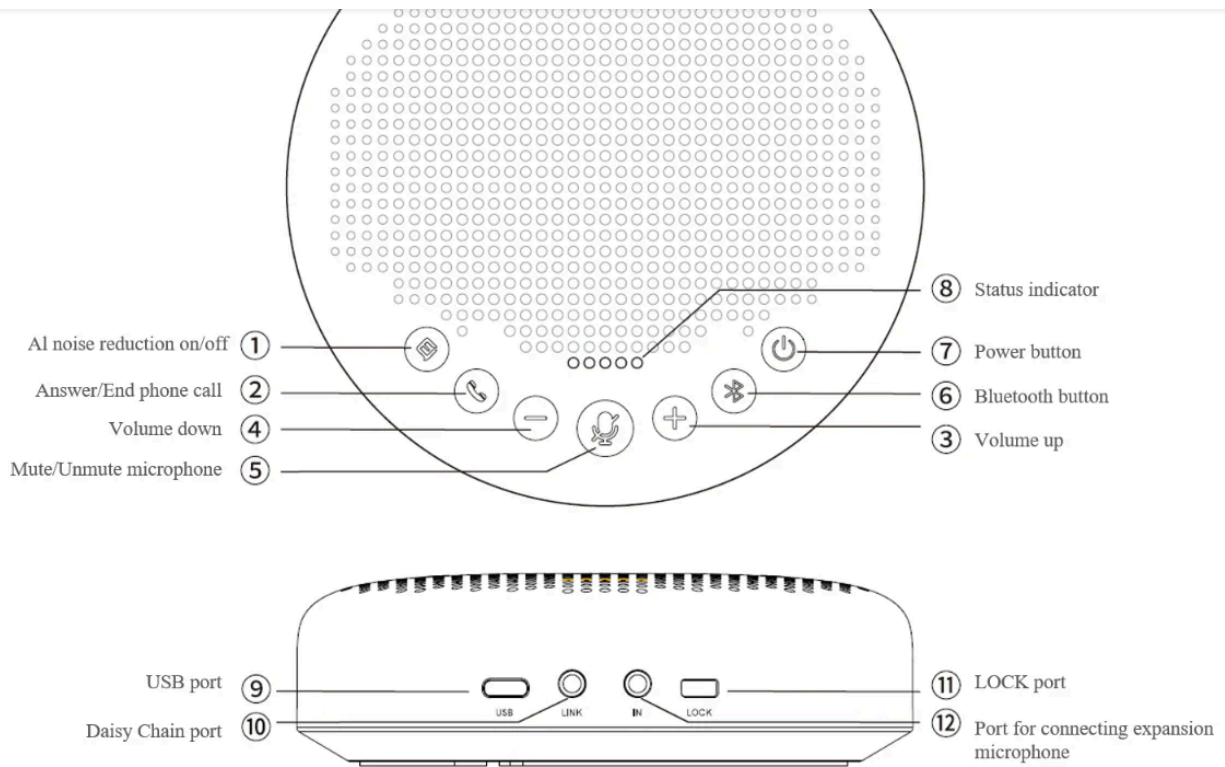



## How to turn on/off the device?

### Manual on/off

Press and hold the power button for 2 seconds to power on or power off the product.

### Auto on/off

Connect the product to a PC via a USB cable to power it on or off automatically.

The product will power off automatically if no connection or operation is performed in 1 hour.



Long press On/Off “  ” for 2 seconds to turn on or off.

**Note:** The auto-off duration can be modified in EMEETLINK software.

## How to connect the device?

### USB Connection

Connect the Luna PLus to your computer by using a **USB-C** cable, then long-press the power button to turn on the device.

When the connection is successful, the status LED light turns **green** to indicate you.

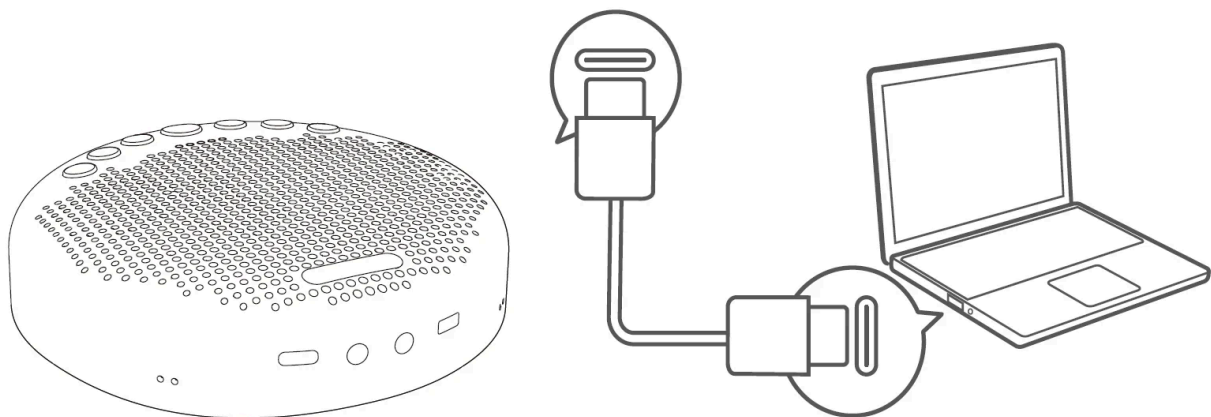

### Bluetooth Connection

#### 1. Connection Steps:

Follow the below steps to pair the Luna PLus to your smartphone, tablet, computer, laptop, or other mobile devices:

a. Turn on the Bluetooth setting on your mobile device.

b. Press and hold the Bluetooth button on the speakerphone for 2 seconds to enter **pairing mode**. In the mode, the status indicator turns **blue and flashes**.

c. Enter the Bluetooth menu of your mobile device, then select Luna PLus from the available devices list. When it is connected successfully, the device status indicator turns **steady blue**.

#### 2. Disconnection



### 5. Long press the Bluetooth button on the Luna Plus the device status indicator turns blue and flashes.

In this situation, to connect via Bluetooth again, you need enter the Bluetooth menu of your mobile device and select Luna Plus from the available devices list.

### 3. Reconnection

When the device is turned on, the Bluetooth will be reconnected to your mobile device(the last connected device) automatically. And there is no need to long-press the Bluetooth button to enter pairing mode.

### USB Dongle Connection

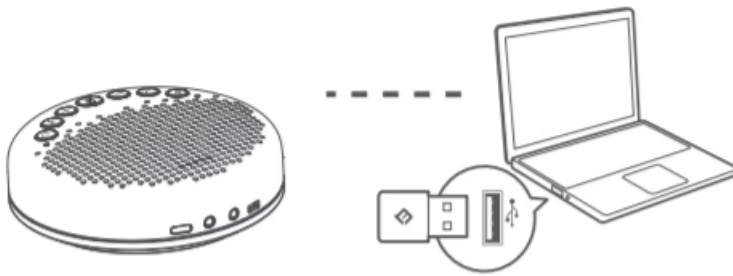

#### 1. Automatically connect

Plug the USB dongle into the computer, the Luna Plus will be connected automatically when it is turned on. And the status LED light of USB dongle & Luna Plus will show **steady blue**.

#### 2. Dongle status

#### 3. Pairing of USB Dongle

To pair a dongle with your EMEET device, please operate as follows:

- Insert the dongle into the computer, and open the Bluetooth of your device.
- Open the EMEETLINK software.
- Click the "Search" button, then click EMEET Luna Plus from the available list.
- When it shows "Connected", the dongle is paired successfully.

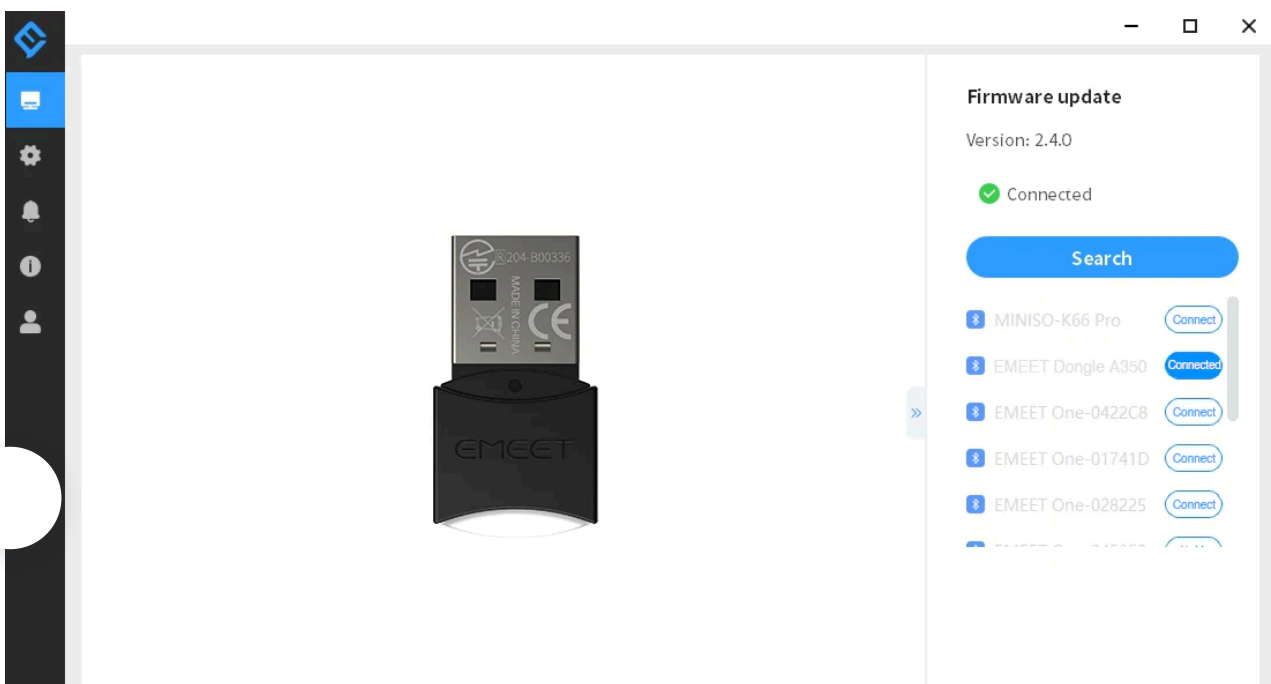



### Expansion Mic Connection

Just simply unfold the 3.5mm cable attached to the expansion mic and plug it into the **IN port** of Luna Plus.

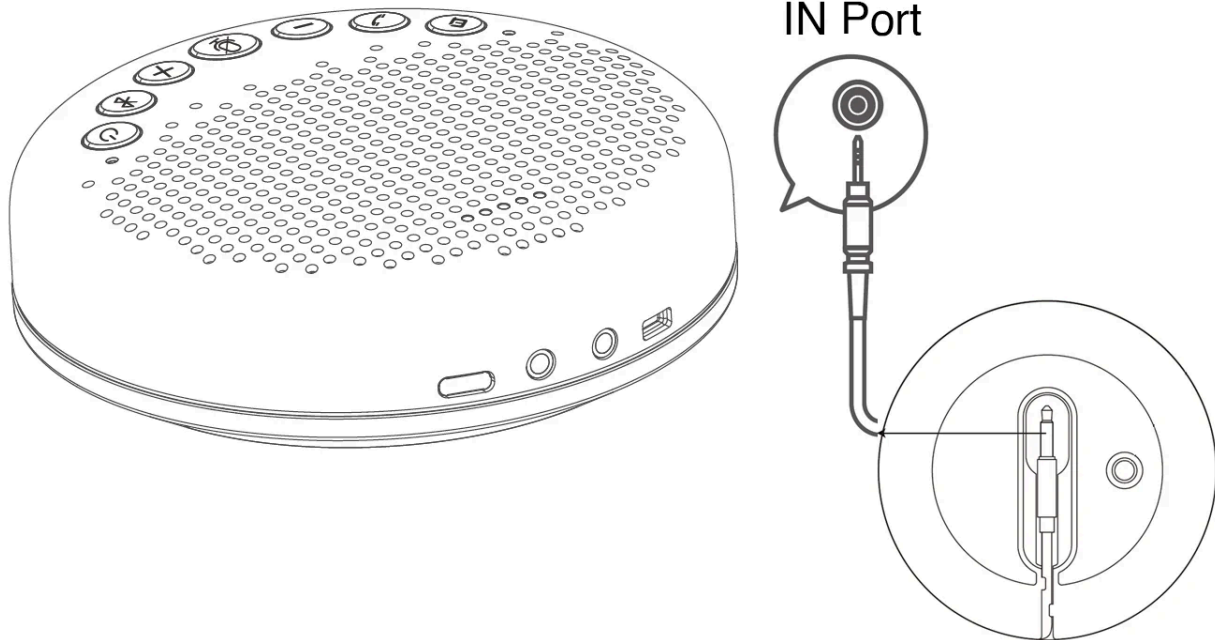

### How to mute the microphone of the device?

Please short press the **mute button** to mute/unmute the microphone of Luna Plus

Just one-click to mute microphone, no need to click the computer interface via mouse.

And when the mute function is turned on, there will be a **red indicator**.



Press  
mute/unmute MIC

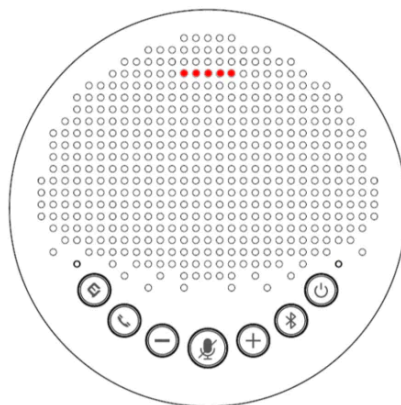

### Can the products be cascaded?



connect the expansion mic to each Luna Plus, achieving synchronous pickup and muting for up to four devices, with a maximum expansion capability of up to 25 people.

### How to use the daisy chain(Cascade Function)?

1. The cascade function requires an EMEET daisy chain cable.
2. Use a daisy chain cable to connect the **OUT/LINK** port of each device.



3. There are two ways to use the cascading function.

#### USB Connection + Daisy chain

Source light of the device shows **green** under the USB connection.

Source light of the device shows **ice blue** when Daisy chains another device.

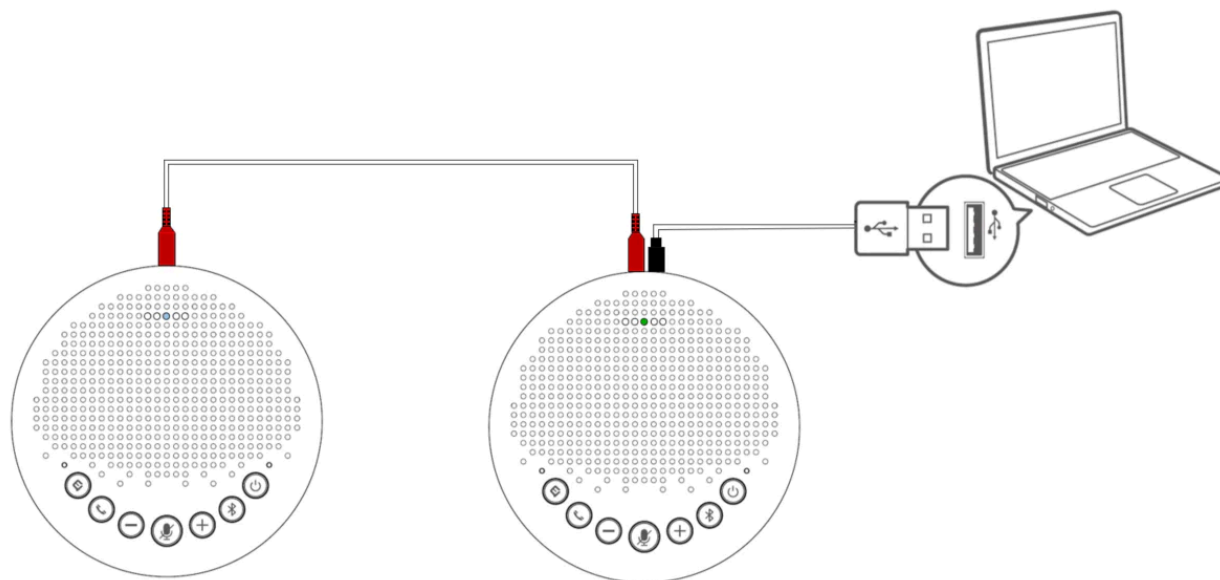

#### Bluetooth Connection + Daisy chain

Source light of the device shows **blue** under Bluetooth connection.

Source light of the device shows **ice blue** when Daisy chains another device.

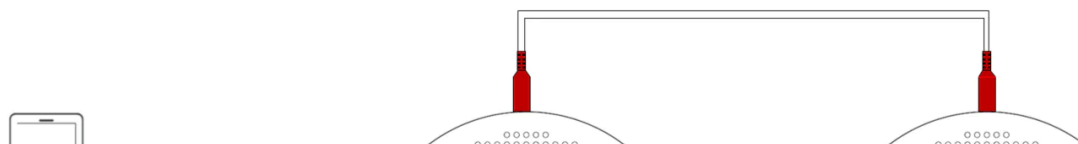

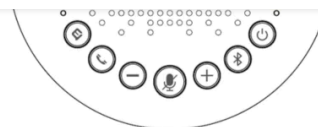

- 4. Microphone Mute button、 Volume "+" "-" button、 Voice IA button can be synchronized while cascading.
- 5. It's an extension of a mono speaker and microphone to improve the range, not stereo.

### How to use the call button of the device?

This function can be used on **telephone communication and Skype for business** when the Luna PLus is connected to your device.

When there is an incoming call, the device indicator will light up flashes green.

Short press to **answer** and **hang up** calls.

Long press for 3 seconds to **reject** calls.

When you use the Luna PLus to answer calls, it will automatically play the call through the speaker.

When you use your phone to answer calls, it will be played through your phone. If you want to play the call via the Luna PLus, just select it when answering the call.

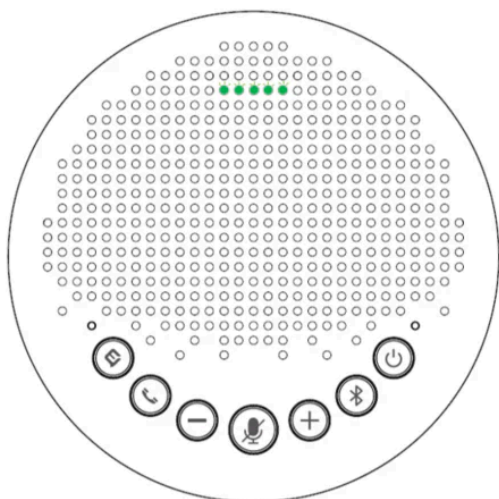

### How to increase/decrease the volume of the device?

Short press the **"+" / "-" button** of the device to increase/decrease the volume of the device.

There are 5 sections of the volume.

Every time you press the "+" button, the volume number will increase 20 with status LED changes.

Until press 10 times, it will up to the max volume with a prompt tone to remind you.



## How to use the Voice IA function of the device?

### 1. What is Voice IA?

- Voice IA is an EMEET independent research and development acoustic technique. It can offer crystal-clear audio when you call.

- The core technologies include reliable full-duplex echo cancellation, microphone array positioning & enhancement, Intelligent voice noise reduction & de-reverberation, and multi-speaker role separation.

- Voice IA is turned off by default. In a quiet conference room without noise, the default mode is generally recommended.

### 2. How to turn it on/off?

**Short press the Voice IA button**, and the function will be turned on/off.

When it turns on/off, there will be a **prompt tone (Voice IA ON, Voice IA OFF)** and an indicator to remind you.

Kindly note, when you make a call at wireless state, there will be no prompt tone.

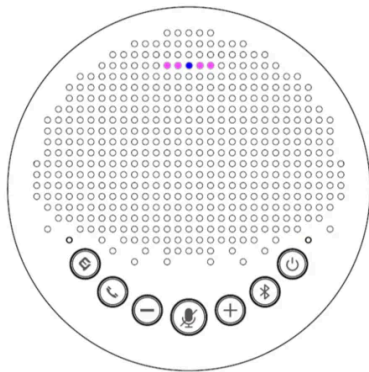

Bluetooth Connection

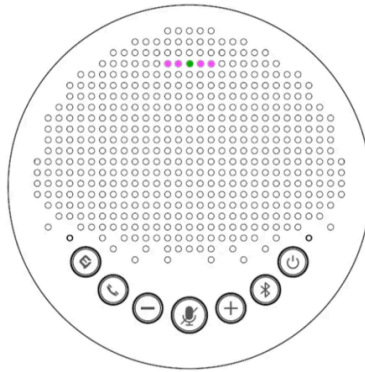

USB Connection



## How to check the device's power? How to charge the device?

### 1. Check battery level

Short press the power button when the device is turned on.

And the device status LED turns **green** to indicate the battery level.

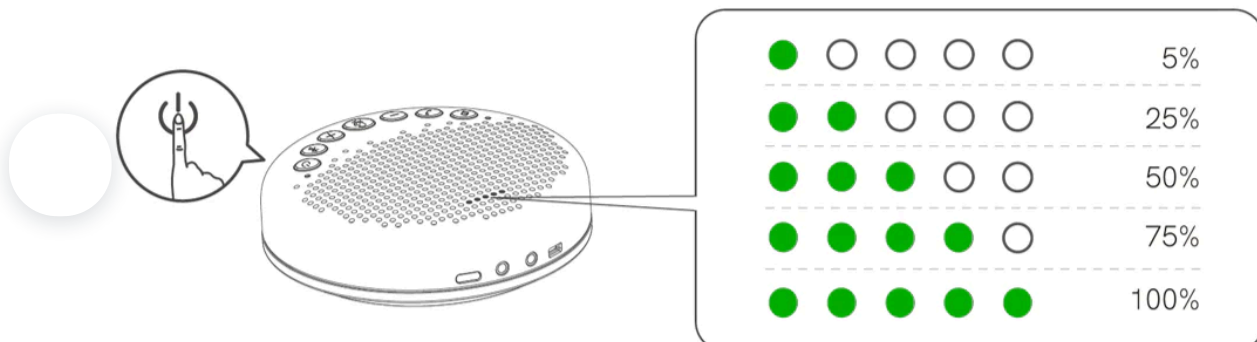



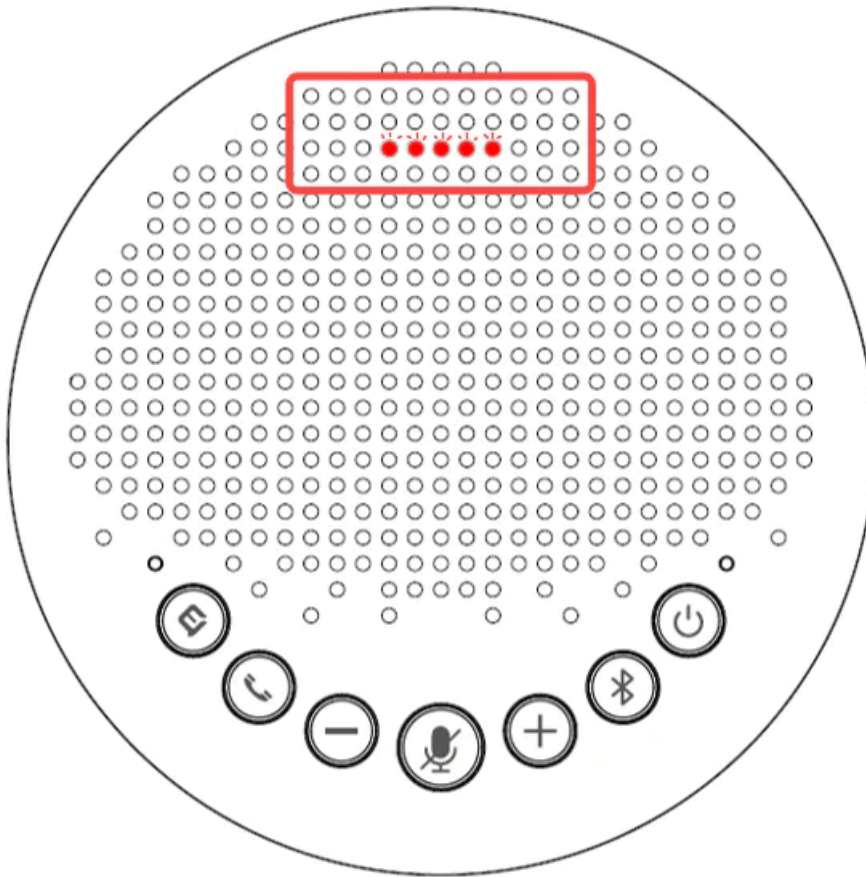

## 2. Charge the device

Please plug the device into an outlet via a USB cable when the device is turned off.

When the battery is not fully charged, the status indicator **lights up yellow-green and flashes.**

When the battery is full, the status indicator **lights up steady yellow-green.**

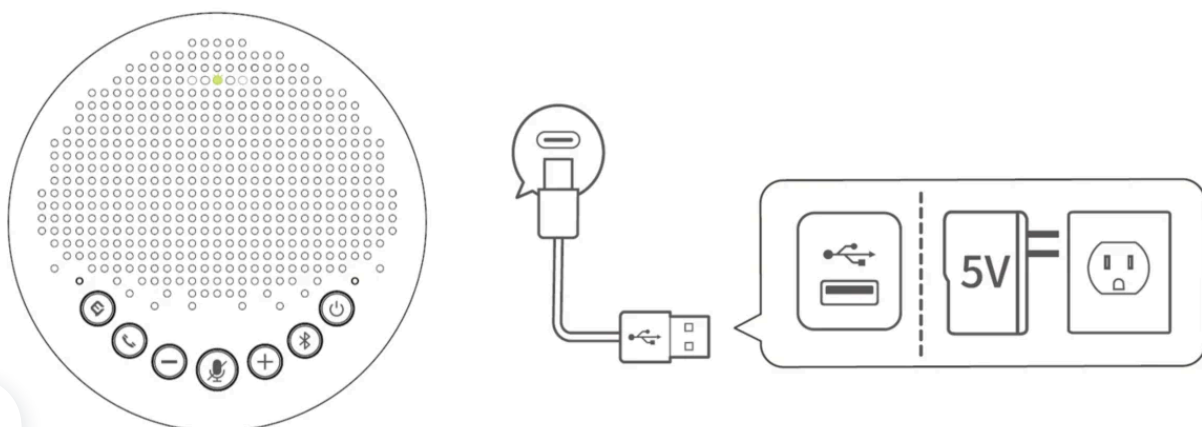

## 3. Battery life and battery capacity

The Luna Plus has a built-in **2600 mAh battery** and when it is fully charged typically supports a **10-hour continuous call**.