

ALLEN & HEATH



DIGITAL MIXING SYSTEM

User Guide

For firmware Version V1.4

Check the Allen & Heath web site for the latest version available

Publication AP8561

Limited One Year Manufacturer's Warranty

This product is warranted to be free from defects in materials or workmanship for period of one year from the date of purchase by the original owner.

To ensure a high level of performance and reliability for which this equipment has been designed and manufactured, read this User Guide before operating.

In the event of a failure, notify and return the defective unit to the place of purchase. If this is not possible then please contact the authorised ALLEN & HEATH distributor or agent in your country as soon as possible for repair under warranty subject to the following conditions:

Conditions Of Warranty

The equipment has been installed and operated in accordance with the instructions in this User Guide.

The equipment has not been subject to misuse either intended or accidental, neglect, or alteration other than as described in the User Guide or Service Manual, or approved by ALLEN & HEATH.

Any necessary adjustment, alteration or repair has been carried out by an authorised ALLEN & HEATH distributor or agent.

This warranty does not cover fader wear and tear.

The defective unit is to be returned carriage prepaid to the place of purchase, an authorised ALLEN & HEATH distributor or agent with proof of purchase. Please discuss this with the distributor or the agent before shipping.

If the unit is to be repaired in a different country to that of its purchase the repair may take longer than normal, whilst the warranty is confirmed and parts are sourced.

Units returned should be packed to avoid transit damage.

In certain territories the terms may vary. Check with your ALLEN & HEATH distributor or agent for any additional warranty which may apply.

If further assistance is required please contact Allen & Heath Ltd.



The GLD range of products complies with the European Electromagnetic Compatibility directives 2004/108/EC and the European Low Voltage directives 2006/95/EC.

Any changes or modifications to the equipment not approved by Allen & Heath could void the compliance of the product and therefore the users authority to operate it.

GLD User Guide AP8561 Issue 4

Copyright © 2014 Allen & Heath. All rights reserved

ALLEN & HEATH

Allen & Heath Limited, Kernick Industrial Estate, Penryn, Cornwall, TR10 9LU, UK

<http://www.allen-heath.com>

IMPORTANT - Read these instructions before starting:

Safety instructions

Before starting, read the [Important Safety Instructions](#) printed on the sheets supplied with the equipment. For your own safety and that of the operator, technical crew and performers, follow all instructions and heed all warnings printed on the sheet and on the equipment panels.

System operating firmware

The function of the GLD is determined by the firmware (operating software) that runs it. Firmware is updated regularly as new features are added and improvements made. This guide relates to [Version 1.4](#) firmware.

The latest firmware can be downloaded from the Allen & Heath web site, transferred to USB key and then loaded into the GLD mixer using the Firmware Update utility. If the AudioRack firmware is different to that running on the mixer it is automatically updated by the GLD mixer when the mixer powers up.

- **Check the Allen & Heath web site for the latest version of GLD firmware.**

Software licence agreement

By using this Allen & Heath product and the software within it you agree to be bound by the terms of the relevant [End User Licence Agreement](#) (EULA), a copy of which can be found on the Allen & Heath website in the product's pages and in the About section of the GLD built-in Help Manual. You agree to be bound by the terms of the EULA by installing, copying, or using the software.

Further information

For further information about the GLD please refer to the user guides associated with each system component. Also refer to the [GLD Touch Screen Reference Guide](#) available on the web site, and use the on-screen [Help Manual](#) available on the GLD-80 surface. Refer to the [Allen & Heath web site](#) for additional downloads, resources, knowledgebase and technical support.

General precautions

- To prevent damage to the controls and cosmetics, avoid placing heavy objects on the control surface, obstructing movement of the motorised faders, scratching the surface or touch screen with sharp objects, or rough handling and vibration.
- Protect the equipment from damage through liquid or dust contamination. Avoid dust or small objects getting into the fader slots. Cover the mixer when it is not being used for a long period.
- Computer and touch screen technology can be affected by extreme cold. If the equipment has been stored in sub-zero temperatures allow time for it to reach normal operating temperature before use at the venue. Recommended operating temperature for GLD is 5 to 35 degrees Celsius.
- Avoid using the equipment in extreme heat and direct sunlight. Make sure the mixer and rack ventilation slots are not obstructed and that there is adequate air movement around the equipment.
- Transport the GLD using a touring grade, purpose designed flightcase with adequate foam lining and internal support for protection.
- Clean the control surface with a soft brush and dry lint-free cloth. Avoid the use of chemicals, abrasives or solvents.
- It is recommended that servicing is carried out only by an authorised Allen & Heath agent. Contact details for your local distributor can be found on the Allen & Heath web site. Allen & Heath do not accept liability for damage caused by maintenance, repair or modification by unauthorised personnel.

Packed contents, registration and accessories

GLD Mixer





Safety Sheets
 AP3345 – English
 AP7287 – French
 AP8513 – Chinese



- Read this before starting

User Guide
 AP8561





Mains lead • Check this is correct for your territory

GLD-AR2412 AudioRack

CAT5 cable
 2m (6.6')
 AH8822

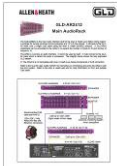
Safety Sheets
 AP3345 – English
 AP7287 – French
 AP8513 – Chinese



- Read this before starting

Information
 AP8596



Mains lead • Check this is correct for your territory

GLD-AR84 AudioRack

CAT5 cable
 2m (6.6')
 AH8822

Safety Sheets
 AP3345 – English
 AP7287 – French
 AP8513 – Chinese

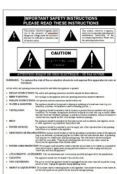
- Read this before starting

Information
 AP8720



Mains lead • Check this is correct for your territory

Register your product online <http://www.allen-heath.com/support/register-product/>

Accessories available

The 2m CAT5 cable shipped with the GLD AudioRack is to get you started or for local connection. For longer distances refer to the Allen & Heath web site for information on recommended cable types. The following are available from Allen & Heath:



120m (396') CAT5 drum
 AH8721 • For use with dSNAKE and ACE™ connection only



80m (264') CAT5 drum
 AH7000 • For use with all GLD CAT5 connections

LEDlamp

Part LEDlampX
 Right angled 4-pin XLR with built-in dimmer



Soft cover

GLD-80 AP8806
 GLD-112 AP9263
 Black, water repellent polyester

ME Personal Mixing System

ME-1 Personal Mixer
 ME-U 10-port PoE hub for ME-1 mixers



Table of Contents

Read before starting.....	3
Packed contents, registration and accessories	4
GLD systems.....	6
Introduction.....	8
System block diagram.....	10
Input and output sockets	11
The GLD Family	12
GLD-80 Mixer controls	13
GLD-80 Mixer rear connectors	14
GLD-AR2412 main AudioRack.....	15
GLD-AR84 expander AudioRack	16
Connect and power up	17
GLD Remote iPad app and wireless router	18
Recall a Template Show as a starting point.....	19
A few things to know before starting.....	23
Working with Scenes.....	27
User Profiles.....	28
USB Playback and Recording	29
How to update GLD system Firmware	30
Specification	32
Dimensions and weights.....	33
Quick start sheet.....	34

Important note about this guide

This user guide relates to **Version 1.4** GLD firmware and is to help you get started setting up and using the GLD. Some details shown in this guide may differ from those in the current release of firmware.

For information on advanced functions not described in this guide, please refer to the **GLD Touch Screen Reference Guide** which can be downloaded from the Allen & Heath web site, and to the **Help Manual** built into the GLD mixer.

- Check the Allen & Heath web site for the latest version of this guide.
- Check the Allen & Heath web site for the latest version of GLD firmware.
- A single sheet **Quick Start Mixing Guide** is provided at the rear of this user guide.



Systems

GLD mixer only 8 in (4 mics), 10 out

4 mics at mixer

Can use I/O module option for networked audio



Standard system 32 in (28 mics), 22 out

24 mics at rack, 4 mics at mixer

GLD-80 or GLD-112 x1

GLD-AR2412 x1

Connect to dSNAKE



Compact system 16 in (12 mics), 14 out

8 mics at rack, 4 mics at mixer

GLD-80 or GLD-112 x1

GLD-AR84 x1

Connect to EXPANDER



Expanded system 40 in (36 mics), 26 out

32 mics at racks, 4 mics at mixer

GLD-80 or GLD-112 x1

GLD-AR2412 x1

GLD-AR84 x1

Connect to dSNAKE



Fully expanded system 48 in (44 mics), 30 out

40 mics at racks, 4 mics at mixer

GLD-80 or GLD-112 x1

GLD-AR2412 x1

GLD-AR84 x2

Connect to dSNAKE and EXPANDER

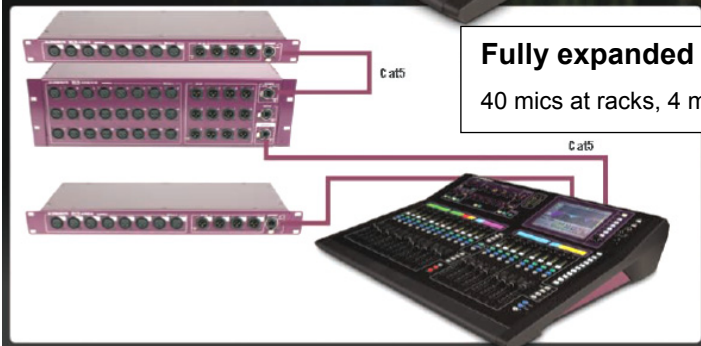

ME PERSONAL MIXING SYSTEM

The GLD can interface directly with the Allen & Heath ME Personal Mixing System to allow musicians, performers and presenters to control their own monitor mix without using up GLD mix buses.

Visit the Allen & Heath web site to find out more.



ME-1 Personal Mixer

Daisy chain connection One or more ME-1 personal mixers can connect to any GLD dSNAKE port (dSNAKE, Expander, Monitor).

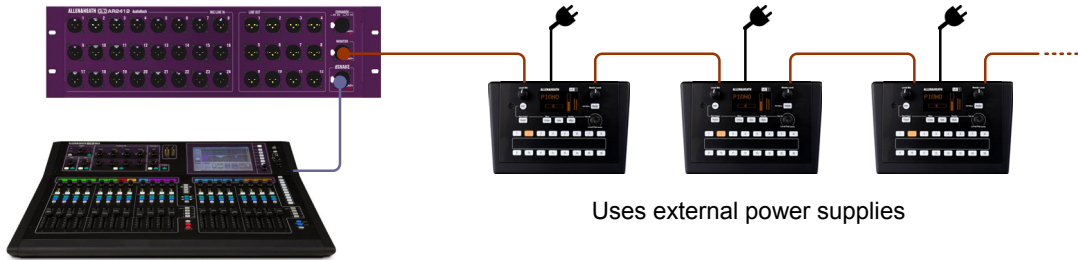

Parallel connection Each ME-1 mixer can be connected with its own cable using a standard PoE Ethernet switch or the Allen & Heath ME-U hub.

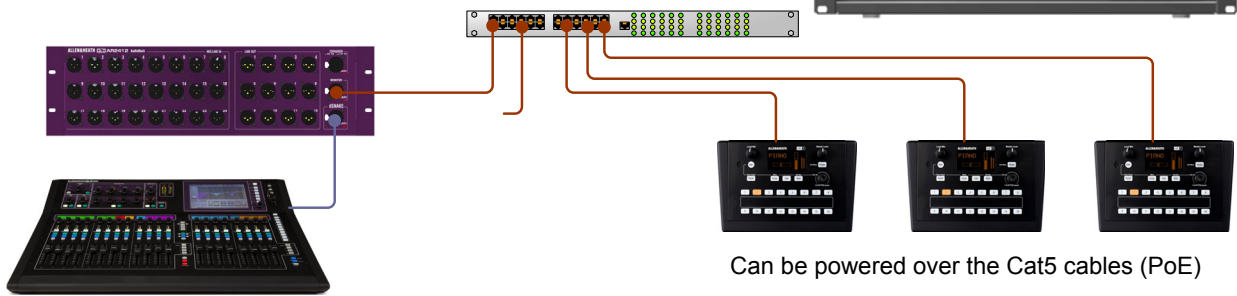

GLD Remote and OneMix apps for iPad

Provides remote wireless control using one or more iPads via a wireless access point (router) connected to the GLD Network port.

GLD Remote allows full remote live mixing control for the engineer. GLD OneMix allows access to just one mix for each musician to control their own personal monitor.

The apps can be downloaded from the Apple Store.

- Note that the GLD mixer firmware and app software must be compatible.



Introduction

GLD is an affordable live sound digital audio mixing system from Allen & Heath. At its low price point and with its intuitive user interface and 'plug n play' connection it provides the perfect upgrade for users of analogue mixers such as the Allen & Heath GL Series, and for small to mid-sized venues, tours and rental companies looking for an affordable yet fully featured and configurable professional digital solution that is easy to learn, operate and maintain.

GLD components

There are two GLD mixers available, the **GLD-80** with 20 faders, and the larger **GLD-112** with 28 faders. The DSP is located in the mixer and can process 48 channels x 30 buses x 20 mix outputs plus 8 'RackFX' internal effects devices with dedicated return channels bringing the total number of sources able to feed the mix to 56. The rear panel provides connections for 8 inputs and 10 outputs plus a slot to fit one of several audio networking cards available from Allen & Heath.

Adding one or more of the available AudioRacks lets you configure systems with up to 40 remote mic inputs in addition to the mixer rear connections. This gives you a distributed audio system with convenient CAT5 digital snake based on the proprietary Allen & Heath dSNAKE protocol. The main I/O (Input/Output) rack is the **GLD-AR2412 AudioRack** providing 24 mic/line inputs and 12 line outputs. It also features a MONITOR port compatible with the Allen & Heath ME and Aviom® personal mixing systems. The **GLD-AR84 AudioRack** is an expander I/O remote rack adding an extra 8 mic/line inputs and 4 line outputs. You can add up to two GLD-AR84 racks, one at the GLD-AR2412, the other at the GLD-80 mixer.

Compatibility with iLive

GLD is not compatible with iLive components, firmware, Libraries or Show files. However, it is compatible with the range of iLive Port B option cards letting you interface easily between GLD and iLive or other systems using a digital snake such as ACE, MAD1, EtherSound or Dante.

Key features

- Plug and play components for systems from 4 to 44 mics
- Easy to use, quick access, analogue style interface with 8.4" colour touch screen
- Remote I/O using dSNAKE CAT5 digital snake - up to 120m (400') length
- High grade 1dB/step recallable mic/line preamps
- 48 channels into 30 buses with 20 outputs – assignable mono/stereo Group, Aux, FX, Main, Matrix
- 8 stereo RackFX engines with dedicated return channels – total 56 sources to the mix
- 64 channel I/O network card option for FOH/Monitor split, recording, link to iLive and more
- Full processing on all inputs – Preamp, trim, polarity, HPF, insert, Gate, PEQ, Compressor, Delay
- Full processing on all outputs – Ext input, Insert, PEQ, GEQ, Compressor, Delay
- Dedicated keys for quick Copy/Paste/Reset of mixes and processing parameters
- Input, insert and output soft patchbays
- GLD-80 = 20 faders, 2 Banks of 4 Layers each – 80 freely assignable strips for custom layout
- GLD-112 = 28 faders, 3 Banks of 4 Layers each – 112 assignable strips
- Virtual write-on strip – 8 colour backlight LCD strip display for naming and colour coding
- 14 user assignable SoftKeys on GLD-112, 10 SoftKeys on GLD-80
- 16 DCA / Mute groups
- Compatible with the Allen & Heath ME personal mixing system and Aviom® A-Net 16.
- USB stereo recording and playback
- Built-in Talkback, RTA display, Signal Generator
- Monitor mode features – Input override output PAFL, engineer's Wedge and IEM strips
- GLD Remote and OneMix iPad apps for wireless mixing and parameter control
- MIDI In/Out and Network ports
- Libraries, Scenes and Show memories
- Scene Filters, Safes, crossfade and embedded Scene function
- 10 User Profiles for restricted operator access
- Get started quickly with Template Shows for classic FOH or Monitor configuration

System block diagram

The block diagram here shows the audio signal flow and processing through the GLD mixer.

The GLD-AR2412 and GLD-AR84 AudioRacks provide inputs as shown in the 'Remote Inputs' box, and outputs as shown in the 'Remote Outputs' box. These signals connect to the GLD via the dSNAKE or EXPANDER ports.

Note the options available for AUX sends, FX sends and global Direct Out. Configuration possibilities are shown for the MIX masters.

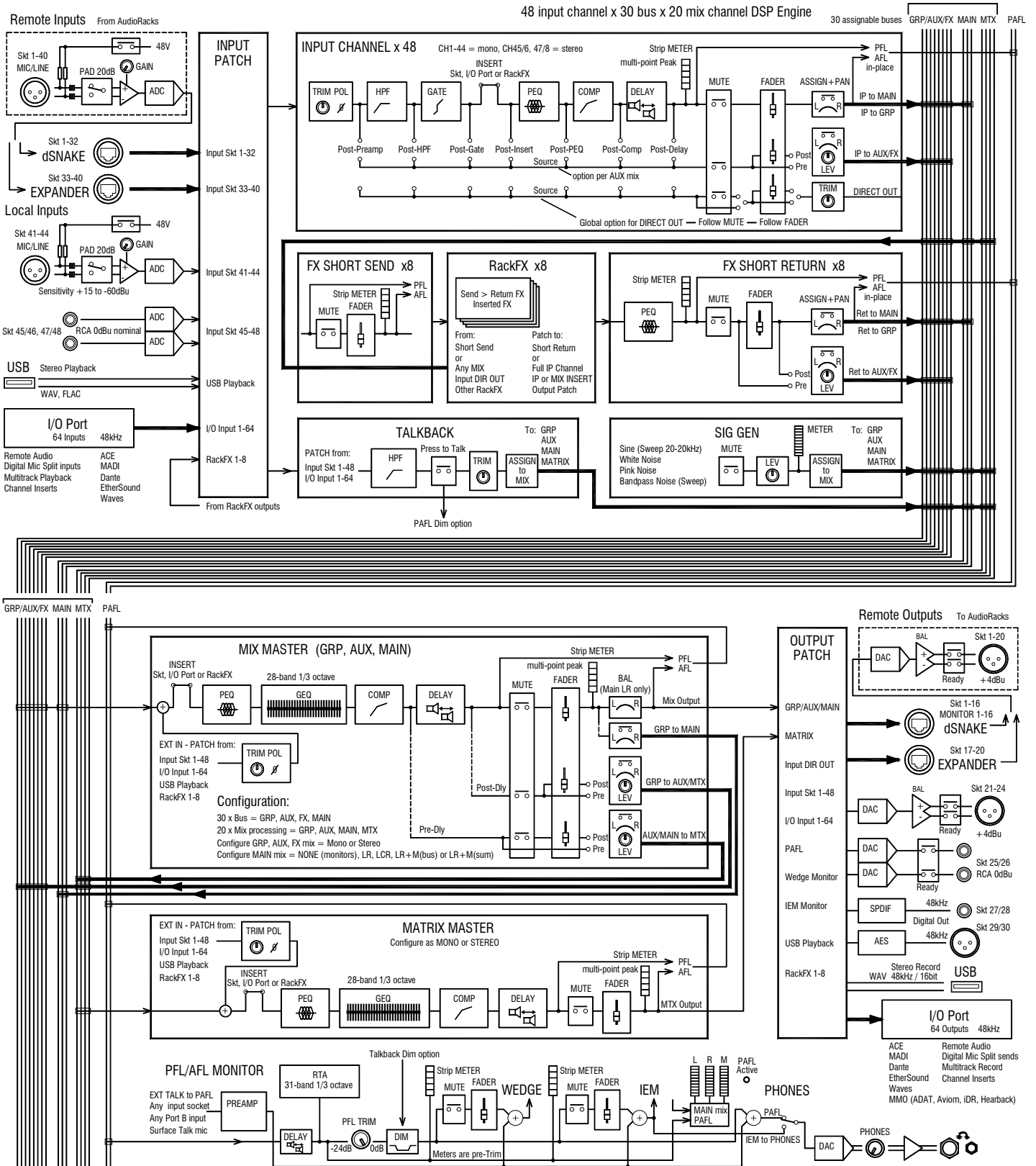

Input and output sockets

The diagram here shows the interconnection and socket numbering of the fully expanded system.

Each socket has a unique number. The physical socket numbers are shown below. Any input socket or source can be patched to any of the 48 channels. Any mix or other GLD signal can be patched to any of the output sockets.

The default is one-to-one mapping, ie. Socket 1>CH1, Socket 2>CH2 and so on.

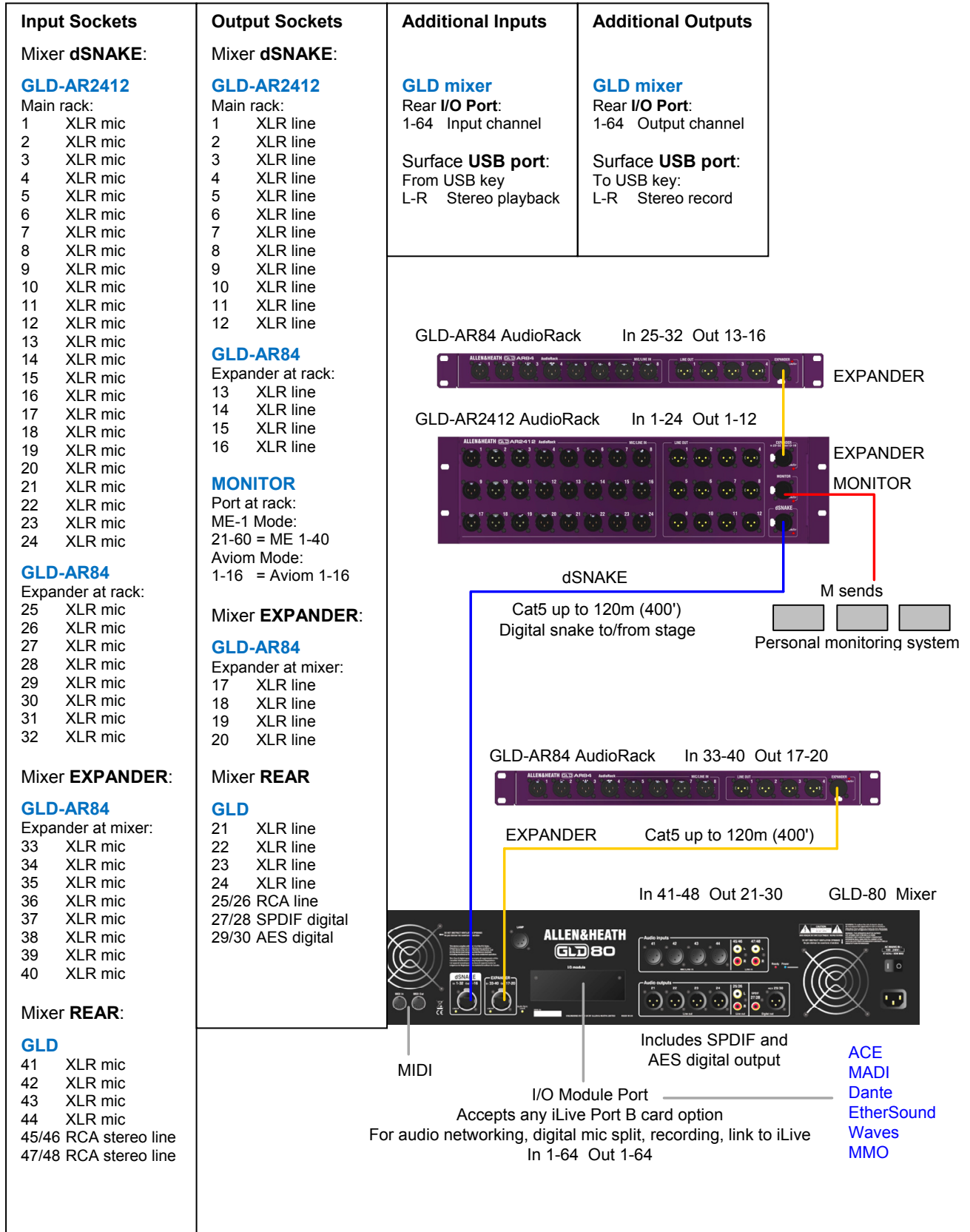



I/O Port fitted with MMO card option

Up to 64 GLD inputs and 64 outputs can be assigned to an audio option card fitted to the GLD rear panel I/O Port. The **MMO** (Mini Multi Out) card provides several output formats – 24 channels of ADAT optical out, two 8 channel iDR links to connect the Allen & Heath iDR-8 or iDR-4 mix processors, or the iDR-Out or iDR-Dout output expander, and also compatible with the HearBus hub, and a 16 channel output compatible with Aviom® A-Net 16 or the Allen & Heath ME personal mixing system running in Aviom mode.

The card uses 56 channels from the port. These are assigned using the **I/O / Port Out** screen. The port channels map to the MMO sockets as below:

GLD Port Map	GLD Port Map	GLD Port Map
Port Out: MMO:	Port Out: MMO:	Port Out: MMO:
ADAT	iDR A	Aviom®
1 ADAT 1	25 iDR-A 1	41 Aviom 1
2 ADAT 2	26 iDR-A 2	42 Aviom 2
3 ADAT 3	27 iDR-A 3	43 Aviom 3
4 ADAT 4	28 iDR-A 4	44 Aviom 4
5 ADAT 5	29 iDR-A 5	45 Aviom 5
6 ADAT 6	30 iDR-A 6	46 Aviom 6
7 ADAT 7	31 iDR-A 7	47 Aviom 7
8 ADAT 8	32 iDR-A 8	48 Aviom 8
9 ADAT 9	iDR B	49 Aviom 9
10 ADAT 10	33 iDR-B 1	50 Aviom 10
11 ADAT 11	34 iDR-B 2	51 Aviom 11
12 ADAT 12	35 iDR-B 3	52 Aviom 12
13 ADAT 13	36 iDR-B 4	53 Aviom 13
14 ADAT 14	37 iDR-B 5	54 Aviom 14
15 ADAT 15	38 iDR-B 6	55 Aviom 15
16 ADAT 16	39 iDR-B 7	56 Aviom 16
17 ADAT 17	40 iDR-B 8	
18 ADAT 18		
19 ADAT 19		
20 ADAT 20		
21 ADAT 21		
22 ADAT 22		
23 ADAT 23		
24 ADAT 24		

Assign each output:

- Unassigned
- Input Direct Out
- Group
- Aux
- Main Mix
- Matrix
- Rack FX
- USB playback
- Input socket
- I/O Port input
- PAFL monitor
- Wedge/IEM monitor

The GLD Family



GLD-112

The larger mixer with 28 faders and 14 SoftKeys.
3 Fader Banks each with 4 Layers = 112 strips
Shelf for iPad



GLD-80

The smaller mixer with 20 faders and 10 SoftKeys.
2 Fader Banks each with 4 Layers = 80 strips

The mixers differ only in size, number of faders and SoftKeys. They both provide the same 48 channel, 30 bus, 20 mix output architecture. They have similar rear panel layout with 8 inputs, 10 outputs, dSNAKE and local Expander ports.



GLD-AR2412

The main AudioRack - Typically positioned on stage and connected to the mixer over a CAT5 'digital snake'. It provides 24 remote mic/line inputs, 12 XLR line outputs, an Expander port and a Monitor port for connecting to the Allen & Heath ME personal mixing or Aviom® A-Net16 system.

● Note that a GLD system can have a maximum of one AR2412 AudioRack connected.



GLD-AR84

The expander AudioRack- Provides 8 remote mic/line inputs and 4 XLR line outputs. You can plug one AR84 into the AR2412 Expander port to expand the number of mic inputs on stage to 32. You can also plug one AR84 into the mixer Expander port to expand the number of inputs and outputs at the surface, or to provide this additional I/O on stage or at a remote location using CAT5 cable.



GLD Remote and OneMix apps

To allow wireless remote mixing control using an iPad with a wireless router connected to the GLD Network port.

GLD Editor software

Set up or control GLD using a PC or MAC. You can download the software free from the www.allen-heath.com.

GLD Mixer controls

Channel Processing Strip Analogue style processing control section presenting the main controls for the Preamp, HPF, Gate, PEQ and Compressor. Press the strip **Sel** key to access the processing for the input or master assigned to it. Further parameter control is available using the touch screen **Processing** screen.

Touch Screen For status display, system setup and memory management. To see details and a graphical view of the processing for the channel or master currently selected make sure it is in **Processing** mode. The keys select the screen mode. Use the rotary control to adjust the value of a highlighted parameter.

Routing select key to display the assignments and sends for the **Selected** strip in the touch screen while in **Processing** mode.

Main / PAFL meters

USB ports For transferring Show files, Libraries and event logs, stereo playback and recording to USB, and for updating system firmware.

Strip LCD display to show channel status information and user defined Name and Colour.

Strip rotary controls
Their function is selected using these keys – Gain, Pan, Custom 1 and 2 (assignable using the **Setup / Control** screen).

Headphones Level control and 1/4" and 3.5mm sockets.

Strip meters The top red indicator lights when a peak is detected at any point in the channel signal path. These meters also display RTA activity while in GEQ on Faders mode.

Press to Talk
Talkback source and destination is assigned using the **Setup / Audio** screen.

Help Touch the ? button to open the built-in **Help Manual**

SoftKeys User assignable functions using the **Setup / Control** screen.

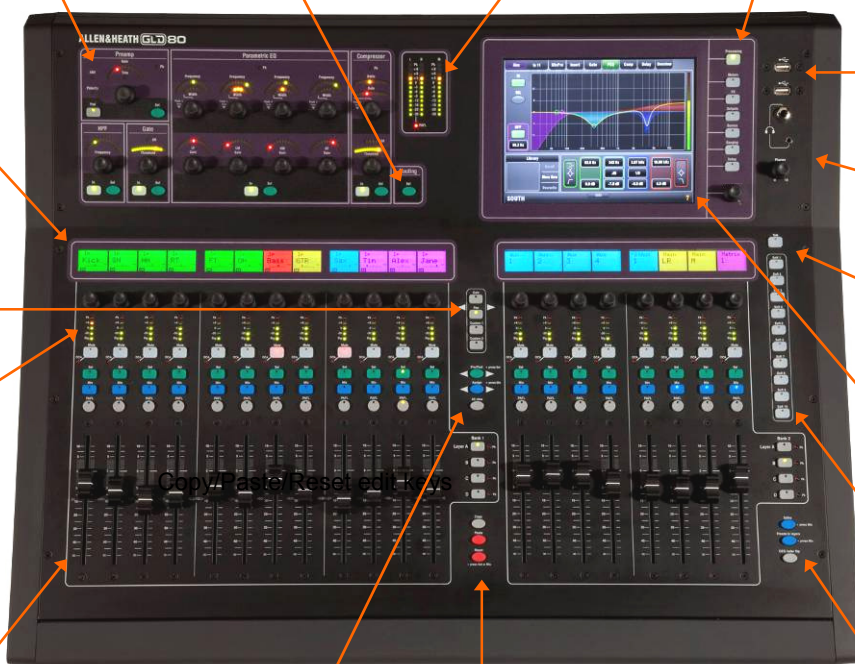

Fader Banks 2 groups of motorised faders with 4 layers each (80 control strips). Provides control of the Input channel, FX return, Mix master, DCA or engineer's Wedge or IEM monitor assigned to it using the **Setup / Control** screen.

Copy/Paste/Reset Hold down Copy and press any **Sel** or **Mix** key to put its related mix or processing parameters on to the clipboard. Then hold down Paste and press a strip **Sel** or **Mix** key to paste its contents to that channel. Hold Reset and press a key to reset the related parameters to factory default.

Hold Reset and push a **fader** to set it to '0' or off.

Mute mutes the channel assigned to the strip. It affects pre and post-fade sends. The DCA indicator lights when the channel is muted by a DCA master assigned to it.

Assign and Pre/Post access keys for the selected mix.

Sel opens the channel processing for the selected strip.

While a **Mix** is active:

Hold down **Assign** and press strip **Mix** keys to toggle the assignments on or off.

Hold down **Pre/Post** and press strip **Sel** keys to toggle sends pre or post fade.

Mix presents the sends for the selected strip on faders and shows the related assignments and pre/post settings in the strip LCD displays.

Toggle all on/off or pre/post while a master is selected by pressing the master strip **Mix** or **Sel** key instead of the channel keys.

PAFL selects either PFL (pre-fade listen) or AFL (after fade listen) according to preferences set in the **Setup / Audio** screen. Input overrides output (mix) PAFL.

The touch screen lower toolbar displays the currently selected mix. You can return to the Main mix by turning the selected **Mix** off, or by turning on then off any other **Mix** key.

Alt View Hold down to view the channel or socket numbers in place of the name in the LCD displays. Set this preference in the **Setup / Control** screen.

Safes Make one or more channels safe from Scene recall by holding down the Safes key and then pressing channel **Mix** keys. A **Safes Map** is also available to make selected parameters safe.

Freeze in Layers Hold down then press strip **Mix** keys to temporarily keep a channel visible across all layers. To assign channels to strips use the **Setup / Control** screen.

GEQ on Faders Presents the GEQ for a **Selected** mix on the faders. Press to toggle between high and low frequencies. Frequency values are shown on the strip LCD displays. The mix master fader is presented on the right hand strip while in this mode.

GLD Mixer rear connectors

GLD sockets can be patched using the **I/O** screen.

Surface audio inputs 8 analogue inputs:

4 mic/line XLR (skt 41-44)

2 stereo RCA pairs (skt 45-48)

Any socket can be patched to any channel. The default is one-to-one mapping of sockets to channels.

Power On indicator
Ready indicator – Lights yellow when the output sockets are ready to pass audio after power up.

4-pin XLR **Lamp** socket. We recommend the use of the Allen & Heath LEDlamp with built-in dimmer.

Cooling fan. Do not block this opening.

The **LOCK** indicator lights when the audio is sync locked

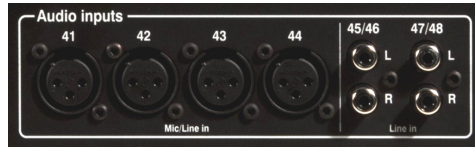

Mains power IEC input socket and On/Off switch.



Network
Ethernet port for wireless router.

I/O Port See below



MIDI in and out

EXPANDER link
You can plug an **AR84** expander in here. This carries audio inputs from **skt 33-40** and outputs to **skt 17-20**.

Surface audio outputs 6 analogue and 4 digital outputs

4 XLR line out (skt 21-24)

1 stereo RCA pair (skt 25/26)

1 SPDIF 2 channel digital out (skt 27/28)

1 AES 2 channel digital out (skt 29/30)

Any GLD signal can be patched to any socket.

dSNAKE link
This is the GLD mixer to **AR2412** AudioRack link. It carries audio inputs from **skt 1-32** and outputs to **skt 1-16**. It also carries the audio sends to the AudioRack MONITOR port.

The AR84 can be located near the GLD mixer to provide more I/O at the mixer, or up to 120m away to provide more I/O on stage or at a remote location.

Connect using a CAT5 cable up to 120m (396') long.

Connect to using a CAT5 cable up to 120m (396') long.

The **Lnk/Err** indicator flashes at a steady rate when the link is established.

The **Lnk/Err** indicator flashes at a steady rate when the link is established.

I/O Port options for system linking, expansion, recording and audio networking using one of the option cards available from Allen & Heath. 64 channel bi-directional 48kHz audio.



ADAT
iDR out
Aviom™
Hearback

GLD-AR2412 Main AudioRack



① **Input sockets** 24 balanced XLR inputs for microphone and line level sources. The preamps are built into the AR2412 rack and their Gain, Pad and 48V phantom power is remote controlled from the GLD mixer via the dSNAKE link. The output of the analogue preamps are converted to digital format and transported via dSNAKE to be processed and mixed at the GLD mixer.

The sockets are numbered 1-24. Any input can be patched to any channel using the **I/O** or **Preamp** screens. The default is one-to-one mapping of the input sockets 1-24 to channels 1-24.

② **Output sockets** 12 balanced XLR outputs operating at nominal +4dBu line level. Any GLD signal can be patched to any socket using the console **I/O** screen. The default Template Shows provide a logical mapping of these sockets to get you started.

③ **EXPANDER port** CAT5 cable link to connect a GLD-AR84 expander rack to add a further 8 mic/line inputs and 4 XLR line outputs. The GLD system numbers these sockets as Inputs 25-32 and Outputs 13-16. This port can also be used to connect to the Allen & Heath ME personal mixing system.

④ **MONITOR port** CAT5 cable link to connect to the ME personal mixing system. It is also compatible with Aviom® A-Net 16 when Aviom mode is selected in the **I/O / Monitor** screen.

⑤ **dSNAKE port** CAT5 cable link to connect the AR2412 rack to the GLD mixer. This carries the 32 inputs, 16 outputs and the monitor port sends audio to and from the rack as well as control for the preamps and system status.

Maximum CAT5 cable length is 120m (396') depending on cable type.

- Note that dSNAKE is not compatible with the iLive ACE connection.



⑥ **Fan** A low noise fan ensures air movement through the rack to keep the circuits within operating temperature range.

- Ensure good ventilation at the back of the rack. Read the safety instructions printed on the panel and the Safety Sheet packed with the unit.

⑦ **Mains power input** IEC connector, fuse and power ON/OFF push switch for the built-in universal voltage power supply unit. This accepts worldwide voltages from 100 to 240V AC 50/60Hz. Check that you have received the correct mains lead for your territory.

Secure the cable in place using the plastic P-clip. Use a T20 Torx screwdriver to refit the screw.

GLD-AR84 Expander AudioRack



① **Input sockets** 8 balanced XLR inputs for microphone and line level sources. The preamps are built into the AR84 rack and their Gain, Pad and 48V phantom power is remote controlled from the GLD console via the EXPANDER link. The output of the analogue preamps are converted to digital format and transported via a Cat5 cable to be processed and mixed at the GLD mixer.

Any input can be patched to any channel using the **I/O** or **Preamp** screens.

The sockets are not numbered. This is because the number depends on where the AR84 is plugged into the GLD system. Write-on blocks are provided for you to label the sockets.

② **Output sockets** 4 balanced XLR outputs operating at nominal +4dBu line level. Any GLD signal can be patched to any socket using the console **I/O** screen. The default Template Shows provide a logical mapping of these sockets to get you started.

The sockets are not numbered. This is because the number depends on where the AR84 is plugged into the GLD system. Write-on blocks are provided for you to label the sockets.

The socket identification is shown in the diagram below:

③ **EXPANDER port** CAT5 cable link to connect the AR84 expander to the EXPANDER port on the AR2412 AudioRack or GLD Mixer.

- Note that the EXPANDER link is not compatible with the iLive ACE connection.

④ **Kensington security slot** To attach a 'Kensington lock' standard anti-theft cable and lock if required.

⑤ **Fan** A low noise fan inside the rack ensures air movement to keep the circuits and internal components within operating temperature range.

- Ensure good ventilation at the back of the rack. Read the safety instructions printed on the panel and the Safety Sheet packed with the unit.

⑥ **Mains cable clip** You can secure the cable in place using the plastic P-clip. Use a T20 Torx screwdriver to refit the screw.

⑦ **Mains power input** IEC connector, fuse and power ON/OFF push switch for the built-in universal voltage power supply unit. This accepts worldwide voltages from 100 to 240V AC 50/60Hz. Check that you have received the correct mains lead for your territory.

Socket numbering

AR84 plugged into the AR2412 main AudioRack:

Inputs 25-32 Outputs 13-16



AR84 plugged into the GLD Mixer:

Inputs 33-40 Outputs 17-20



Connect and power up

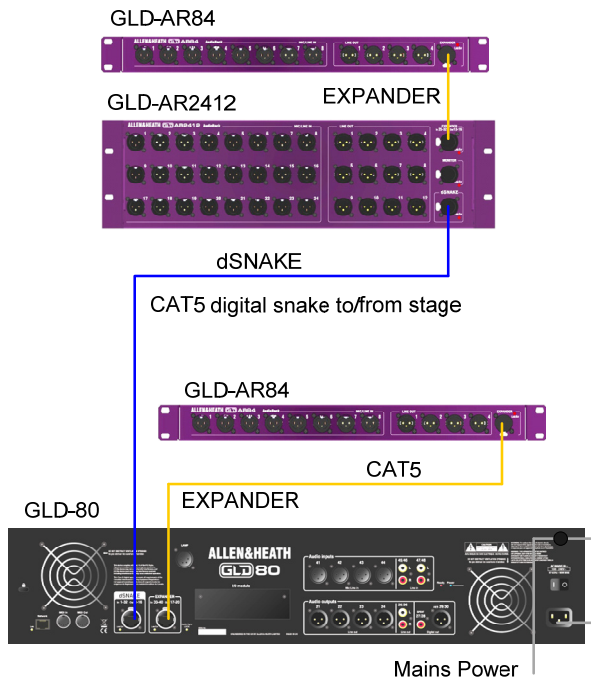

Connect the AR2412 AudioRack Plug a CAT5 cable into the dSNAKE port at the rack and mixer. This is the main system link.

Connect the AR84 AudioRacks Plug a CAT5 cable into the EXPANDER port of the AR84 and the EXPANDER port of the AR2412 or GLD mixer.

- Always plug the AR84 into an EXPANDER port. Do not plug it into the dSNAKE port even if you are not using an AR2412 main rack.

Plug in the mains power leads supplied with the mixer and racks. Secure the leads by hooking them into the plastic clips. If required the leads can be locked into these clips. Use a T20 Torx (starhead) screwdriver to remove the fixing screw.

To turn on the system Turn on power using the rear panel On/Off switches.

The GLD takes around 40 seconds to boot up. Its screen lights white for a few seconds, then turns black displaying its boot sequence. A while later the **Home** screen is displayed. At this point the yellow **Lnk/Err** indicators of connected dSNAKE and EXPANDER ports start to flash steadily showing that the link between the mixer and racks is established. The mixer Audio Sync **LOCK** indicator lights. Finally, the AudioRack **Ready** indicators light and you will hear a click as the output socket protection relays switch over.

- If the **firmware** in a connected AudioRack is not the same version as that in the GLD mixer then the mixer will automatically update the rack firmware during power up. This takes a few seconds. During this time the **Lnk/Err** indicators on the AudioRack flash at a fast rate. Once updated normal flash rate is restored.

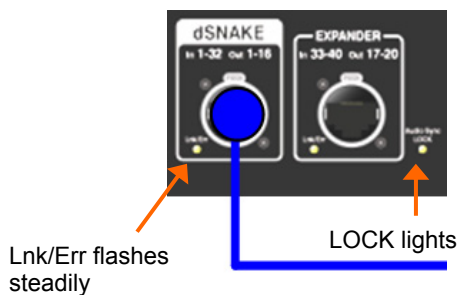

To turn off the system The system must be powered down correctly. Return to the **Home** screen. To do this turn off any active **Sel** key whilst in the **Processing** view.

Touch the **Power Down** button. A popup appears. Confirm the action then turn the mixer and racks off using their power switches.

- If the system is not powered down correctly there is a possibility recent changes may be lost.
- If the system was not powered down as described above then a **'Not shut down correctly'** screen appears the next time the system is turned on.



GLD iPad app and wireless router

GLD Remote and **GLD OneMix** iPad apps allow wireless control of mixing and processing using one or more iPads. GLD Remote allows simultaneous control of different functions by more than one engineer, for example one engineer controlling the FOH mix at the GLD surface and another controlling monitors on stage using an iPad. GLD OneMix allows personal monitor control for the musicians.



The router:

- Good wireless range
- Dual band (2.4 and 5GHz)
- Auto channel select
- Adjustable antennas
- Good security

Recommended settings:

GLD (default)
Static IP = 192.168.1.50
Subnet Mask = 255.255.255.0
Router
Router IP = 192.168.1.254
Subnet Mask = 255.255.255.0
DHCP 192.168.1.100 to 200
Security = WPA



Get the app Download the app from the Apple Store. You can open it in Demo mode without a GLD connected to get a feel for how it operates and to read the ? Help Manual within the app.

- Make sure the App and GLD firmware versions are compatible. Check the Allen & Heath web site for the latest firmware.

Choose a router (wireless access point) The GLD app is a professional mixing tool that justifies network equipment of suitably high performance, quality and reliability.

For best performance we recommend you choose a dual band wireless router with auto channel selection. Use the more recent 5GHz band in places where there is intense WiFi activity or interference in the more crowded 2.4GHz band. A wireless router with auto channel selection automatically sets itself to an available or least congested channel when you power it up.

Refer to the Allen & Heath web site for more information on choosing wireless routers for use with the Allen & Heath iLive and GLD systems.

Set up the router You will need to connect it to a PC using a wired LAN connection. Follow the instructions provided by the wireless router manufacturer to access its setup menus.

Set the router IP address - This must be compatible with the GLD console which has a default static IP address = 192.168.1.50 and Subnet Mask = 255.255.255.0. Go to the **Setup / Config / Network** screen to check the current GLD settings.

To work with the GLD you must give your wireless router a unique but compatible IP address. Some routers may have a default address that is not compatible and must be changed, for example 192.168.2.1. Some may already be compatible, for example 192.168.1.254.

Set the router DHCP settings - Make sure the router is set for DHCP so that it automatically allocates a compatible IP address to your iPad. To avoid conflict with the GLD static address we recommend you set a router DHCP address allocation range of 192.168.1.100 to 200.

Note You do not need to change the GLD setting to DHCP. The console will work fine with a static IP address as long as it is not within the router DHCP address range.

Set the router security -To prevent other people accessing your Wi-Fi we recommend you enable WPA/WPA2 encryption during router setup. A wireless key (password) will need to be set up.

Make a note of the router SSID. This is the name that the router broadcasts to help identify it in the network list you will see in the iPad Settings Wi-Fi page. If you want you can change the SSID to help you identify it alongside other wireless networks in the area.

After setup, the wireless router can be connected to the Network socket on the rear of the GLD console using a CAT5 cable. Plug this into one of the LAN (not Internet) ports on the rear of the router.

Position the router Make sure it is within the specified range and in line of sight of the iPad where possible. It can help to place it high up to avoid obstacles such as people and equipment. Avoid locating it behind pillars or walls, near metal beams or on top of loudspeakers.

Recall a 'Template Show' as a starting point

The GLD has a fully configurable audio architecture, control layout and socket patching letting you customise the way you work. It would be a daunting task for the new user if we gave them a 'blank canvas' to start from scratch. Instead we have provided a set of 'Template' Show memories which give you a choice of classic console format to load in as a quick starting point. These present the familiar architecture and logical layout of well-equipped analogue consoles.

Once you are comfortable working with GLD you can make changes to your set up and save these as your own 'User' Shows. These let you archive and recall the complete configuration and setup. Use Scenes for instant store and recall of band sound checks, theatre cues and different event settings. Scenes are stored within the Show.

A **Show** memory stores the complete GLD setup. This includes:

- Current settings
- Mix configuration
- User preferences
- All Scene memories
- All Libraries

A default show is already loaded when the GLD is shipped from the factory. This is **Template1 LR**. You can load a different Template as your starting point if you wish:

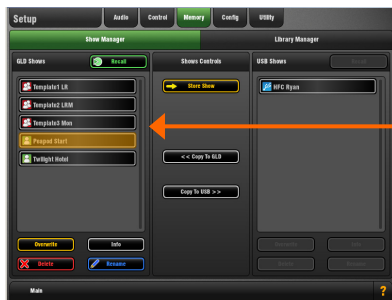

To load a Template Show Go to the **Setup / Memory / Show Manager** screen. Available Shows are listed. These include Template and User Shows.

Touch the **Template Show** you want to load. Touch **Recall**. A popup appears for you to confirm the action.

- Recalling a Show overwrites all the system settings including the DSP mix architecture, Surface configuration, current parameters, all the Scene and Library memories. If you want to keep the current settings to be used again in the future then first **Store** them as a **User Show**.

The Show Manager screen

Touch a Show name to highlight and select it.

Recall the selected Show.

Store a new User Show. This opens the keypad. Type in and Apply a name for the Show.

Template Shows
Shown with a red icon. These cannot be deleted.

User Shows
Shown with a green icon.

Overwrite, Delete or Rename an existing User Show.

Info shows details on file size and when the highlighted Show was last modified.

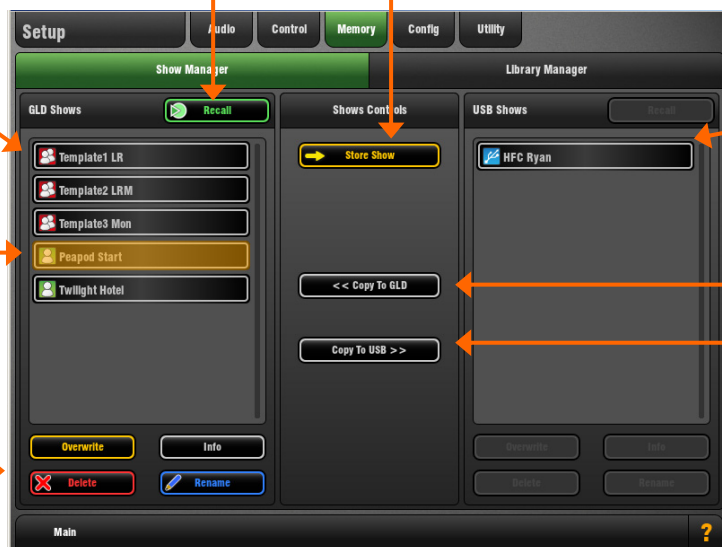

USB Shows
Shown with a blue icon.

Copy Shows from the USB key to the GLD, or from the GLD to USB.

These controls become available when a USB key is plugged in and is recognised.

Template Show settings

There are three Template Shows available as a starting point for classic FOH and monitor mixing applications.

Template1 LR	Stereo main mix. Use for FOH or mixing monitors from FOH.
Template2 LRM	3-way main mix with separate Mono bus for centre or fill speaker
Template3 Mon	Dedicated monitor mixer with 6 wedge and 6 stereo IEM mixes

These have the following common settings:

- SoftKey assignments are Scene Safe
- SoftKeys 1-8 = DCA mute 1-8
- SoftKey 9 = PAFL Clear All
- SoftKey 10 = FX4 tap tempo (FOH only)
- SoftKey 11-12 = Unassigned • Scene Confirmation = On
- Global Direct Out = post-delay, pre-fade, post-mute (ready for ME-1 personal mixer sends)
- Monitor Port = ME-1 mode
- I/O Port out = input socket 1-48
- PEQ = 20-20kHz, Curve Fill = On
- Talkback = Momentary, Dim off
- Template1 and 2 FOH - Auxes are post-PEQ, pre-fade
- Template3 Mon - Auxes are post-fade
- FX are post-fade (effects)
- USB playback assigned to CH47/48
- USB recording from LR via stereo Matrix1
- Scene 1 and 499 (backup) = 'Reset GLD-80' (Template default)
- Scene 2 and 500 (backup) = 'Reset GLD-112' (Template default)
- Scene 498 = 'Reset MIDI Strips' (restores default MIDI Strip message settings)

The Template Show 'Board Reset' Scene Each Template Show provides two 'Reset' scenes in position 1 and 2. These reset the GLD-80 or GLD-112 mixer settings to the starting point default for the loaded Template Show. These Board Reset Scenes are duplicated in positions 499 and 500 at the end of the list.

Use this Scene to instantly reset parameters without affecting the mix configuration, user preferences or the other Scenes. You can edit its Recall Filter to protect parameters you do not wish to reset. For example, you could set the filter to protect the patchbay and master strip assignments in a festival situation.

- You can also set Scene Safes to protect selected parameters for all Scenes, for example the patchbay, or SoftKeys.

When creating your own User Show from a Template Show you can choose to overwrite the Scene 1 and 2 contents with your preferred settings, rename them, write in a description, set their Recall Filters to reset selected parameters only, or simply delete them. You can still access the default reset using Scene 499 or 500 if needed.

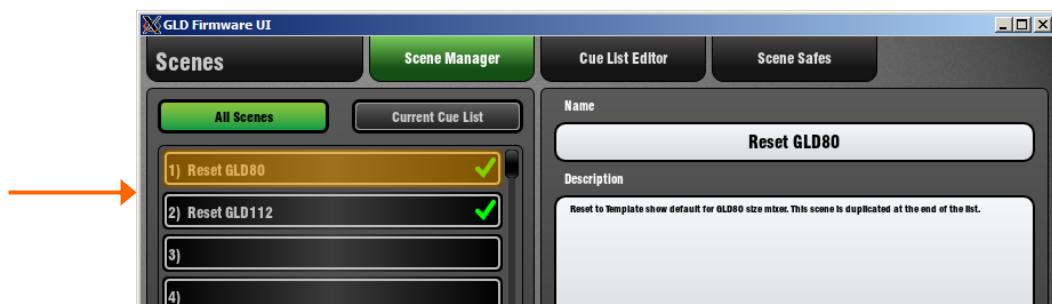

Template1 LR

This Template configures a traditional architecture and layout with stereo LR main mix for mixing FOH and Monitors from FOH. This is the factory default Show loaded.

LR stereo main mix	The Front-of-House main mix using a single master fader.
4 Groups (2 stereo)	For example, use these to EQ or compress groups of inputs such as drums, backing vocal or radio mics, or to send to a Matrix to create a different balance in fill speakers, or to group several inputs to record to mono or stereo tracks.
8 Auxes (6 mono, 1 stereo)	Typically used for monitor sends such as wedge speakers and stereo in-ear systems.
8 FX (4 assigned to strips)	3 reverb and a delay effect are assigned to the faders. 4 more effects send and returns can be assigned or inserted into channels or mixes.
6 Matrix (2 mono, 2 stereo)	Ready for use as additional speaker sends such as delay fills and remote zones, or for separately controlled recording, broadcast and video feeds.
Recording from stereo Matrix 1	Set up ready to feed a stereo recording sourced from the main LR mix. Its send and master are turned up. Its output is patched to analogue and Spdif connections on the rear panel. It is also patched as the source to the USB stereo recorder.
16 DCA / Mute groups	Use these for muting and controlling the levels of groups of signals such as drums, vocals and effects. 6 DCA masters are assigned to the faders. You can assign more as required.
Talkback using mic socket 44	Rear panel mic input 44 is patched as the Talkback source. For this reason CH44 is not assigned to the LR mix. You can assign it to LR if you are not using talkback.
USB playback to CH47/48	Playback from the USB key is patched to a stereo channel.

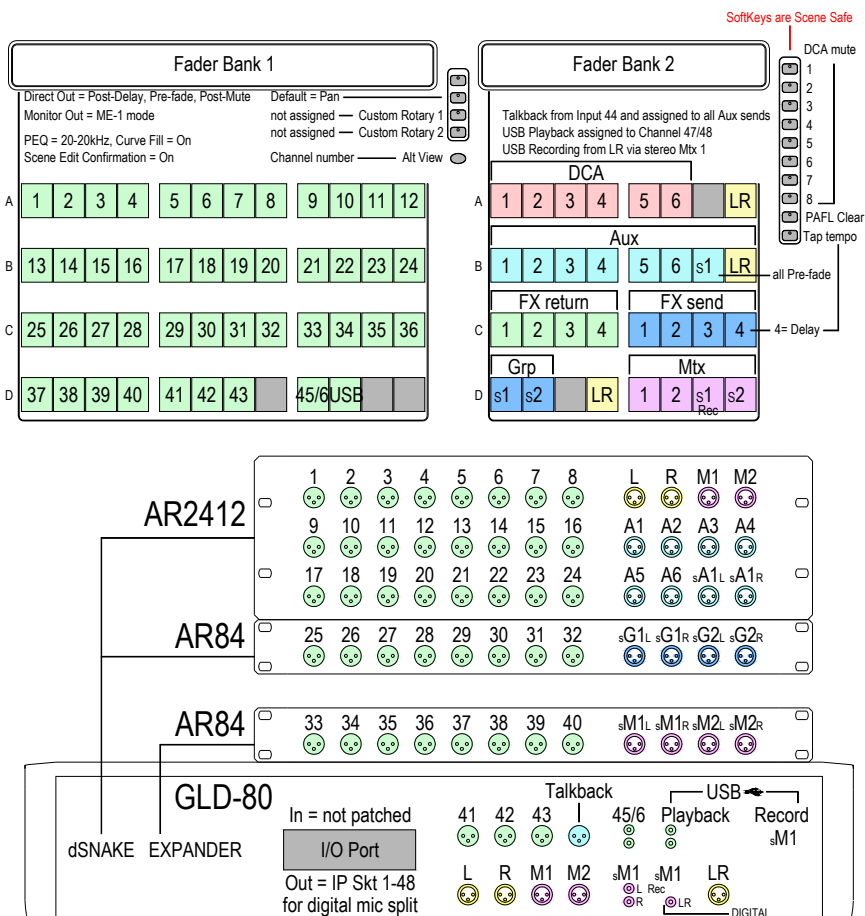

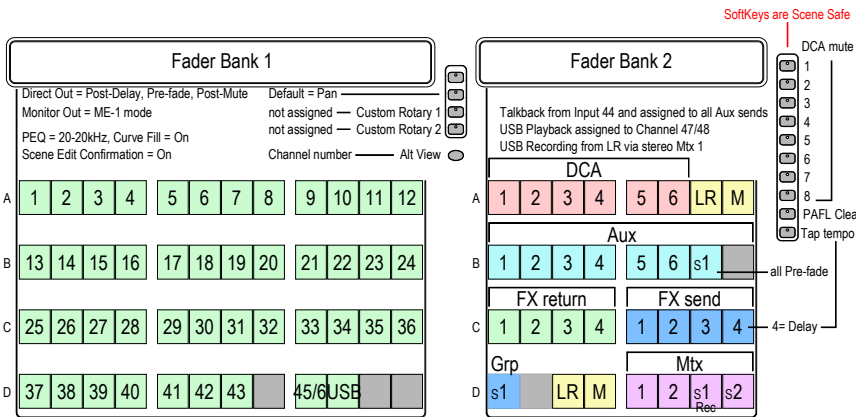

Template2 LRM (also use for LCR)

This Template configures stereo LR plus Mono bus for working with a 3-way FOH mix.

You can change the type of 3-way Main mix from LR+M (switched bus) to LR+M (mono sum of LR) or LCR using the **Setup / Config / Mixer Config** screen.

LR + Mono (switched bus) main mix
2 Groups (1 stereo)

8 Auxes (6 mono, 1 stereo)

8 FX (4 assigned to strips)

6 Matrix (2 mono, 2 stereo)

16 DCA / Mute groups

Talkback using mic socket 44

USB playback to CH47/48

Recording from stereo Matrix 1

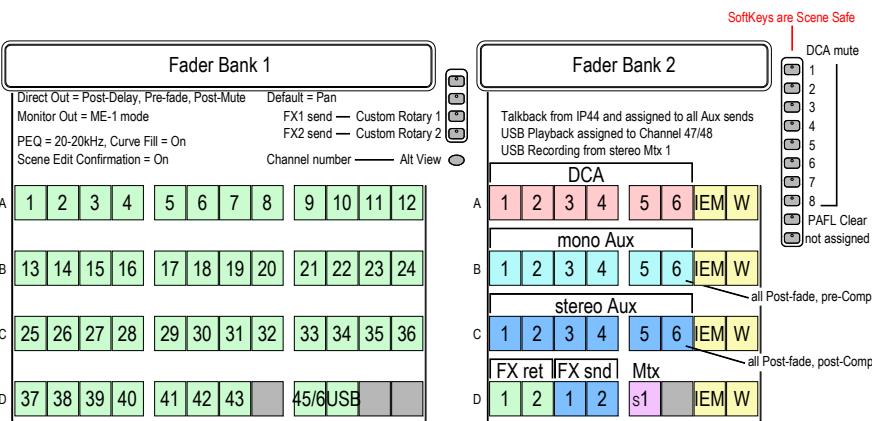
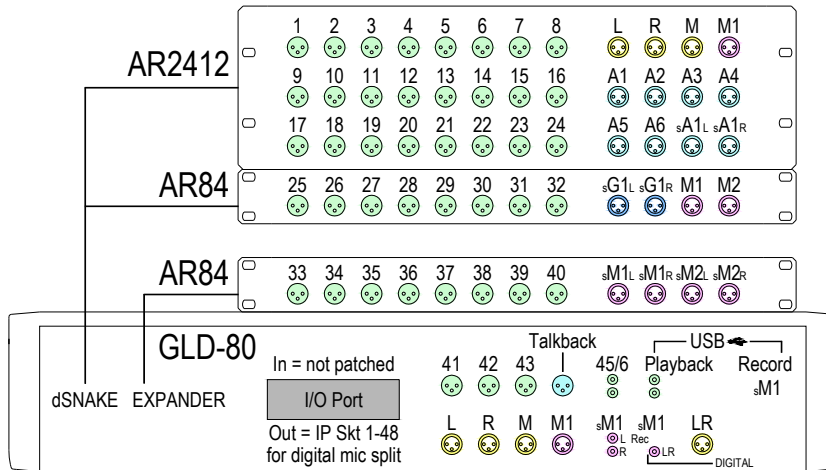

Template3 Mon

This Template configures the GLD as a dedicated monitor console with 18 mixes:

6 mono mixes (wedges, fills)

6 stereo mixes (IEM)

Auto switching engineer's Wedge/IEM

8 FX (2 assigned to strips)

Talkback using mic socket 44

USB playback to CH47/48

Recording from stereo Matrix 1

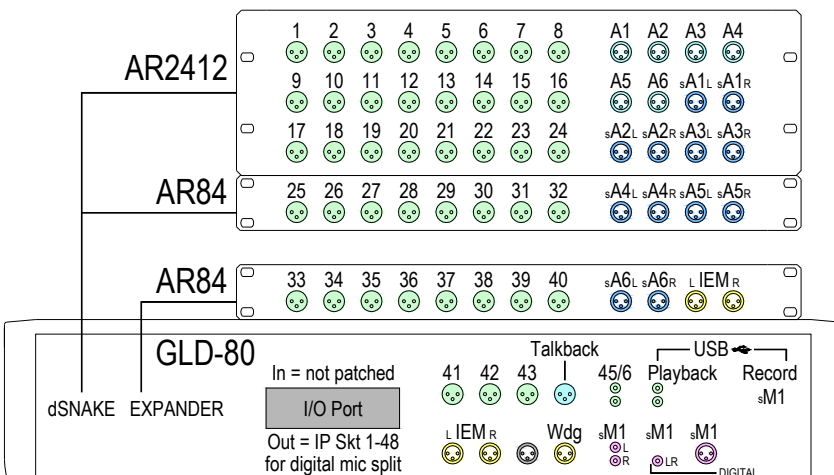

The engineer's IEM/Wedge monitor is configured so that pressing a mono Aux (wedge) mix PAFL key will automatically mute the engineer's stereo IEM monitor. Pressing a stereo Aux (IEM) mix PAFL key will mute the engineer's Wedge monitor.

A few things to know before starting

Before working with the GLD familiarise yourself with its control layout and operating principles.

The Touch Screen

Screen **graph view** for PEQ and dynamics:

Touch a pick-up box and drag the curve. Values are displayed in the parameter buttons.

You can adjust parameters using the graph, touch buttons or processing section rotary controls to the left of the screen.

Name and Colour button

Tabs to select the pages available for the current screen

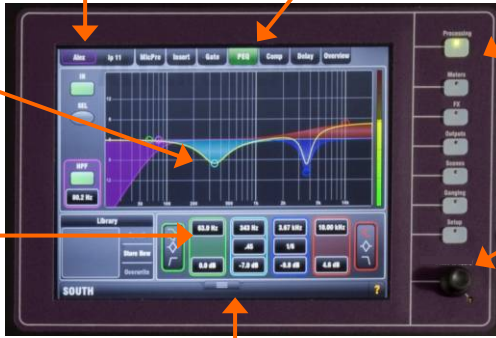

Screen select keys:

Press a key to select that view. Press the key again to return to **Processing** view.

Screen rotary control:

Touch a parameter on the screen to highlight it, then turn the rotary to adjust its value.

- Processing
- Meters
- FX
- I/O
- Scenes
- Ganging
- Setup

Pull-up tab opens additional controls and options for the current screen

The Home Screen

This screen displays after power up. You can return here by turning off any active strip **Sel** key while in the screen **Processing** view. You can also do this by turning on, then off any strip **Sel** key.

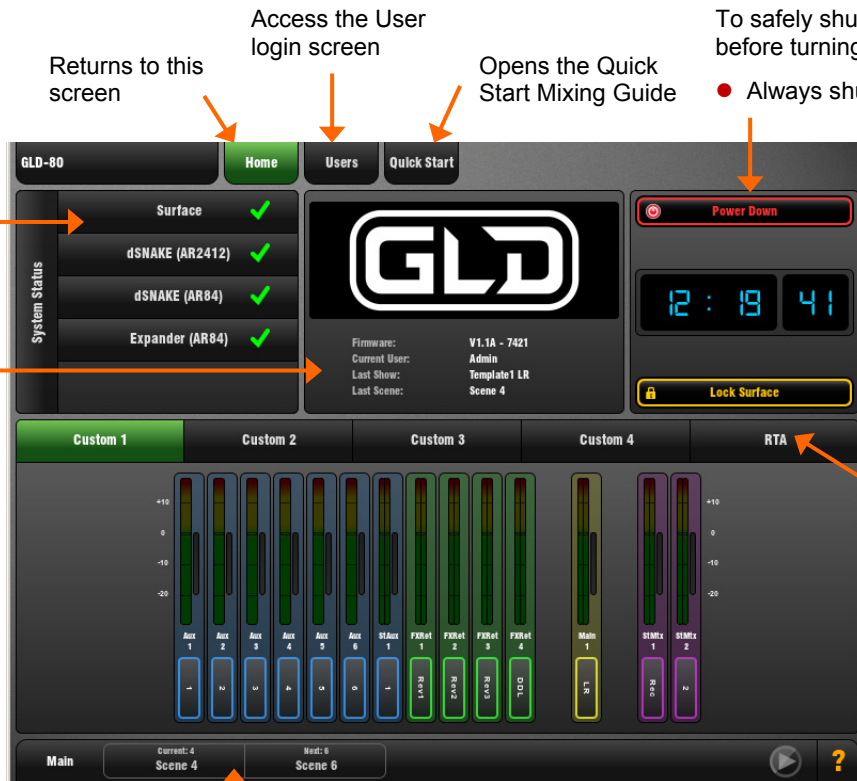

Returns to this screen

Access the User login screen

Opens the Quick Start Mixing Guide

To safely shut down the GLD computer before turning the system off.

● Always shut down using this button.

Displays system connection status

Displays system information

Real time **clock**. Set the date and time using the **Setup / Utility / Date/Time** screen.

To **lock** the surface controls. Can be password protected.

Tabs to open one of the 4 custom meter pages or the RTA (real time analyser) display. The RTA follows the PAFL signal. Custom meters are assigned using the **Meters** screen.

Touch **?** to open the Help page for the current screen. You can also access the main Help menu from here.

The last Scene recalled and the Scene highlighted in the Scene list ready to be recalled are displayed here.

Shows which **Mix** is currently selected.

● Look here to check that you are on the correct mix. For example, remember to turn off an Aux **Mix** key to return to the **Main** (LR) mix after adjusting a monitor level.

Shows USB playback and recording status. Touch to open the **USB Audio** screen.

The strip LCD display

The LCD strip above the faders displays information about the channels assigned to the faders. Channels can each be named and have one of 8 backlight colours applied. You can edit these names and colours to easily identify different channel and mix types, or highlight certain instruments and sources.

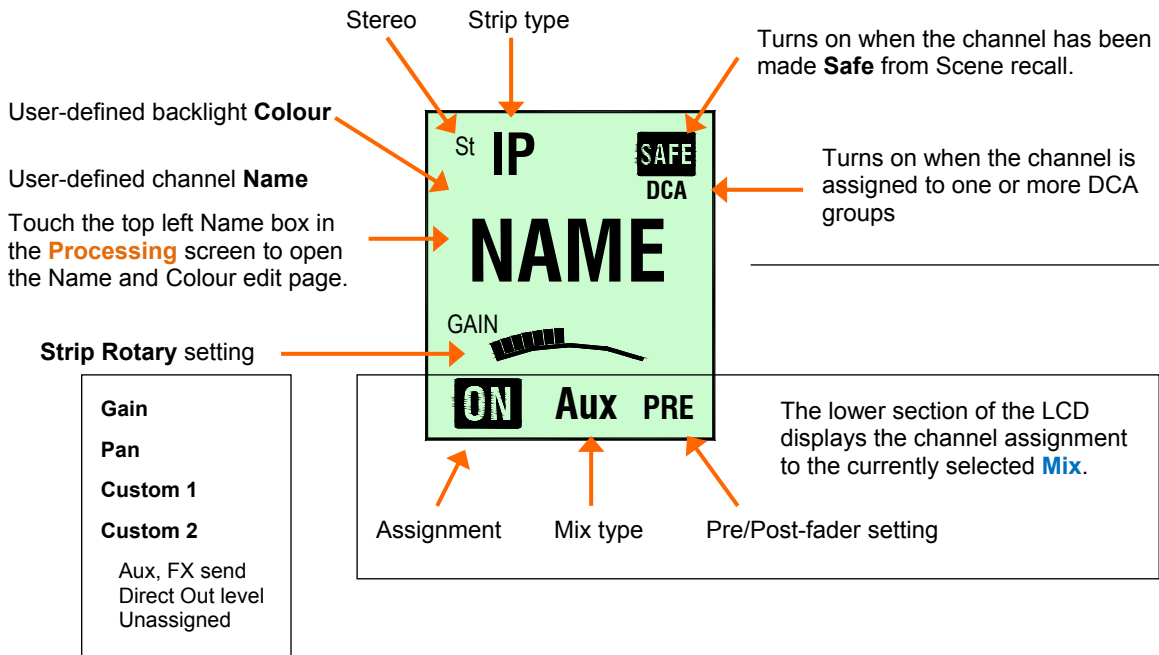

Select the function of the strip Rotary controls using these keys. The Custom keys are assigned using the **Setup / Control / Surface Prefs** screen.

- Check that you have selected the correct function when working with the rotary controls.

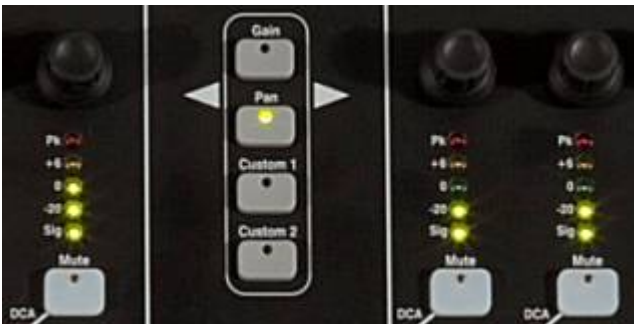

Press and hold the **Alt View** key to see the Channel Number, Socket Number or fader dB value in place of the Name in the LCD display.

Choose the Alt View function using the **Setup / Control / Surface Prefs** screen.

The Fader Banks

The GLD-80 mixer has 2 independent Fader Banks, one with 12 fader strips, the other with 8 fader strips. The GLD-112 has 3 Fader banks with 12, 8 and 8 faders. Each Bank has 4 Layers. This means that the GLD-80 can work with up to 80 fader control strips and the GLD-112 with up to 112 strips.

Any strip can be assigned as an Input channel, Mix master, FX send master, FX Return, engineer's Wedge or IEM master, or DCA master in any combination. Strips can be left blank (unassigned). The Template Shows provide a logical assignment of the fader strips to give you a familiar starting point.

To change the fader strip assignment use the **Setup / Control / Strip Assignment** screen. You can drag-and-drop to quickly reassign the strips.



The Fader Strip keys

4 keys per strip provide quick access to important live mixing functions:

Lights when the channel is muted by a DCA

Mute Turns off the channel signal. Affects the main mix and pre-fade and post-fade sends. This is important in live mixing, for example to mute an acoustic guitar in both the FOH mix and monitors when the musician unplugs it.

Sel Instantly selects the processing for the channel. The rotary control section to the left of the touch screen becomes active to control the Preamp, HPF, PEQ, Gate and Compressor for that channel.

- To see and adjust the processing using the touch screen make sure the screen **Processing** key is selected.

Mix Puts the send levels and assignments of the associated channel or master onto the fader strips. For example you can work with all the sends to one Aux shown on the input faders by selecting its master strip **Mix** key. Or work with the sends from one channel to all the Auxes shown on the master faders by selecting the channel **Mix** key.

- Be aware of which Mix is currently selected. For example, when you have finished adjusting an Aux send, press its **Mix** key again to turn it off and return to the main mix. The currently selected mix is displayed in the lower left screen toolbar.

PAFL Sends the channel PFL (pre-fade listen) or AFL (after-fade listen) signal to the GLD headphones and monitoring system. Preferences for the PAFL system are set using the **Setup / Audio / PAFL** screen.

Input PAFL overrides mix master PAFL.

Working with the **Mix** on the fader strips

Normal mix mode (FOH)

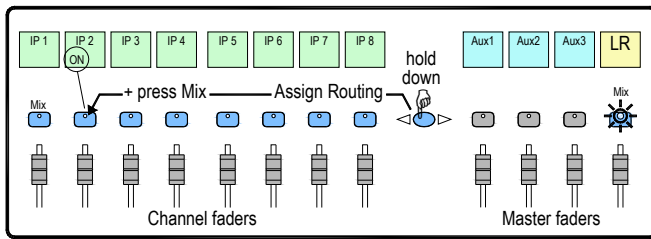

Press a Main Mix master strip **Mix** key.

This is the normal mixing mode. The Input strips present the channel faders. The Master strips present the master mix faders.

Hold down the **Assign** key and press channel **Mix** keys to assign or de-assign them from the main mix. Current ON status is displayed on the lower part of the strip LCDs.

Master Mix view

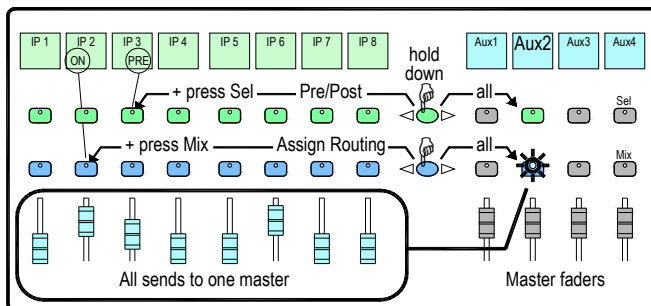

Press a Mix master strip **Mix** key.

Use this to work with Aux and FX sends. The Input strips change to present all the send levels to the selected mix. The Master strips present the master mix faders.

Hold down the **Assign** key and press channel **Mix** keys to assign or de-assign them from the selected mix.

Hold down the **Pre/Post** key and press channel **Sel** keys to toggle each source pre or post fader. Current PRE status is displayed on the lower part of the channel strip LCDs.

You can quickly set **all** assignments on or off, or all sources pre or post fader by pressing the Master strip **Mix** or **Sel** key instead of a channel key as described above.

Channel Mix view

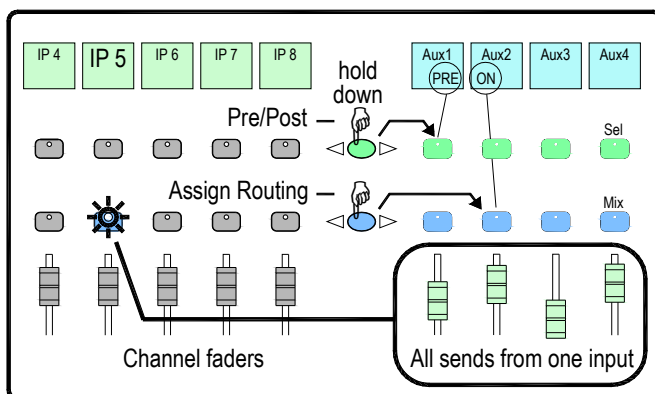

Press an Input Channel strip **Mix** key.

Use this to work with Aux and FX sends. The Input strips remain as Channel Faders. The Master strips change to present all sends from the selected channel.

Hold down the **Assign** key and press master **Mix** keys to assign or de-assign the channel from each mix.

Hold down the **Pre/Post** key and press master **Sel** keys to toggle the channel pre or post fader to each mix. Current status is displayed on the master strip LCDs.

DCA and Audio Group assign

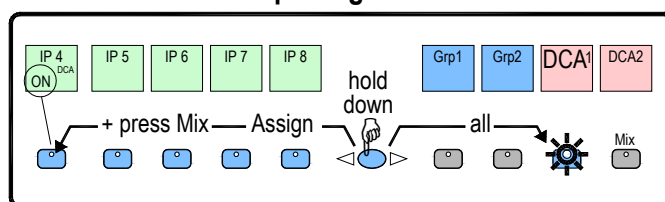

Press a Group Master strip **Mix** key.

Use this to assign channels to the Audio and DCA groups. The Input and Master faders are not affected.

Hold down the **Assign** key and press channel **Mix** keys to assign or de-assign the channels from the group.

Working with Scenes

GLD has 500 Scene memories. These are 'snapshots' of the live mixing parameters. They store all current mix settings but not the bus configuration and user preferences. Use **Scenes** to store parameter changes you want to recall instantly, for example cues during a theatre production or sound checked bands during a music show. Use **Shows** to store and archive the complete GLD setup including its bus configuration, user preferences and all Scene memories.

A Scene **stores all parameter settings**. A **Recall Filter** is available for each Scene to let you choose which parameters to recall. For example, work with just the channel fader levels and mutes for a range of Scenes, or change an EQ on one channel using a Scene. You can **name** Scenes, add a **description**, **copy and paste** their settings to other Scenes, **delete** their contents, and create **Cue Lists** from selected Scenes arranged in any order and repeated any number of times.

Global **Scene Safes** can be set to protect selected parameters being overwritten by the Scene system. These can be set using the **Scene Safes** screen. You can also fully protect a channel or master from Scene recall by pressing the **Safes** key together its strip **Mix** key. For example, to protect background music and continuity announcement while a band sound check is recalled.

Refer to the [GLD Touch Screen Reference Guide](#) for more information on using Scenes and the other functions accessed via the screen.

Annotations for the Scene Manager interface:

- Display the full list of 500 Scenes. (Points to 'All Scenes' button)
- Display a **Cue List** of selected Scenes. (Points to 'Current Cue List' button)
- Create, name, save and load Cue Lists using this screen. (Points to 'Cue List Editor' tab)
- Choose to make select parameters globally Recall **Safe** using this screen. (Points to 'Scene Safes' tab)
- Touch to open the keypad and **name** the Scene. (Points to 'Name' field)
- Set a crossfade time to affect faders, send levels and pan. (Points to 'Crossfade Time' field)
- Type in a **description** for the Scene. (Points to 'Description' text area)
- Touch to **recall** the selected Scene. (Points to 'Recall' button)
- Touch to view and edit the **Recall Filter** for the selected Scene (Points to 'Recall Filter' button)
- Delete** the selected Scene. (Points to 'Delete' button)
- Store** the current settings to the selected Scene. This will overwrite existing Scene settings. (Points to 'Store' button)
- Embedded Scene Recall function (refer to the Help manual). (Points to 'Embedded Recall' button)
- Touch to **Copy** the currently selected Scene ready to be pasted to one or more other Scene positions. This copies the Scene contents but not its name. (Points to 'Copy' button)
- Highlight a Scene in the list then touch **Paste** to overwrite its contents with those of the copied Scene. It also copies the settings of the Recall Filter. (Points to 'Paste' button)
- You can paste one Scene to multiple positions in the list. (Points to 'Paste' button)
- Touch **OPTIONS** to turn the Scene Editing Confirmation option on or off. This affects Scene Store, Recall, Delete and Copy using the Scene Manager page. (Points to 'OPTIONS' button)

The last Scene recalled and the Scene highlighted in the list ready to be recalled are displayed in the status bar. When the Scene is recalled its name briefly flashes green to confirm the action.

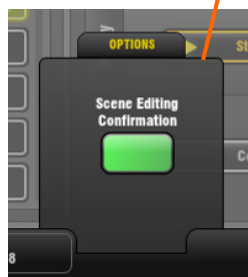

User Profiles

GLD lets you set up and work with up to 10 'User Profiles' including an Administrator and 9 Users. You can set permissions and a password to restrict operator access to certain functions.

The **User List**. 'Admin' has access to all functions and can set permissions and allocate passwords if required for the other users. Up to 9 guest users may be configured and activated.

Icons show if a User is **ON** (active), has a **password** set, or has a **User Scene** set.



Touch to open the keypad and Apply a **name** for the selected User.

Touch to set or change the **password**. This is entered twice to avoid errors.

You can add a **comment** to display here and on the Login screen. For example, provide details about or instructions for each user.

You can choose a **User Scene** which will recall when a different user with a Scene set logs in. This does not recall when the same user logs in. Choose 'No Scene' if none is required.

Touch to open the **Set Permissions** page. Here you can enable or disable any combination of functions to restrict how much control and access you give each User.

Refer to the [GLD Touch Screen Reference Guide](#) for more information on using User Profiles and setting their Permissions.



Category tabs group the different types of user permissions available.

List of permissions for the selected category show if they are enabled (ON) or disabled (OFF).

A **description** of the parameters affected for the highlighted permission is shown here.

Touch to **enable or disable** the highlighted permission.

Touch **Apply** to save your changes or **Cancel** to return to the User Profile page without saving.



To log in as a different user Go to the **Home / Users** screen and select a User. Touch **Login**. The User can also be changed from the GLD power up Login screen which appears when a password is set for the current user.

If a **password** has been set then you are prompted to enter it when you log in, turn the system on, or lock and unlock the Surface.

If a **User Scene** has been set then this will be recalled, but only if you are logging in as a different user.

USB Recording and Playback

Play back stereo audio tracks from a USB key and record any pair of GLD sources on to the key.



Audio file list shows the tracks available to play back.

Playback controls and information about the currently selected track.

Patching information and shortcut to **I/O** screen.

Recording control to start/stop the recording. Opens the screen keypad to apply a name before the recording starts.

OPTIONS pull-up to choose which audio files to show in the list and select single, repeat or continuous playback.

Playback/Recording status shown here. You can touch this while in any screen to open the **USB Audio** screen.

Playback - The GLD can play back stereo WAV or FLAC files at 44.1 or 48kHz.

To assign USB playback to an Input Channel – Patch USB Playback to input channels using the **I/O / Surface** screen or the channel **Preamp** screen. USB playback is assigned to Ch 47/48 in the factory Template Shows.

To select a track to play back - Plug in a USB key with the audio files you wish to play back. Set the **OPTIONS** in the pull-up. Scroll through the list and touch to highlight a track. Information on the track including file path, size and date is displayed.

To start the playback - Use the transport buttons to **Play**, **Pause**, **Stop** and select **Next** or **Previous** track. A blue arrow in the lower toolbar in all screens shows a track is playing.

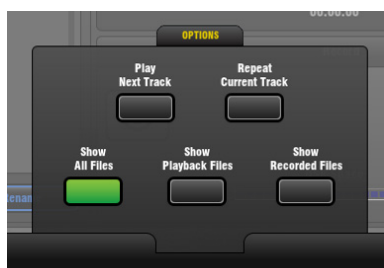

Open the **OPTIONS** pull-up to set playback options:

Play Next Track - Single or continuous playback.

Repeat Current Track - Continuously play a single track,

Show All Files – List all audio files in all directories found on the USB key,

Show Playback Files – List audio files found in the USBPlayback sub directory only.

Show Recorded Files –List audio files found in the USBRecord sub directory only.

Recording – Format = WAV files at 48kHz.

Recording time – Maximum recommended recording time for one track = 3 hours. Memory required = 188KB/sec. Therefore allow:

- 11.5MB per minute
- 700MB per hour

To assign a recording source – Use the **IO / Surface** screen. For example, record the main mix, a stereo group, aux or matrix, or two independent mono signals. USB recording is fed from Stereo Matrix1 in the factory Template Shows.

Check recording level – If you are using a source other than the Main mix, for example a stereo Matrix, then check that the send level to the source and its master fader are turned up. Check that there is signal displayed on the source meter.

To start the recording - Touch the **Record** button. This opens the name keypad. The default date/time name can be overwritten using the keypad. Default example = 15_Apr_18.23.26.wav

Touch **Apply** to start the recording. The elapsed time and remaining time available on the USB key is shown. A red circle in the status bar in all screens indicates that the GLD is recording to the key.

To stop the recording – Touch the **Record** button again.

USB Folders

The **AllenHeathGLD / USBRecord** directory is automatically created on your USB key when you start a recording.

The **AllenHeathGLD / USBPlayback** directory is automatically created when you select the Show Playback Files pull-up option. Or you can create it manually using your computer and add the files you wish to play back.

How to Update GLD System Firmware

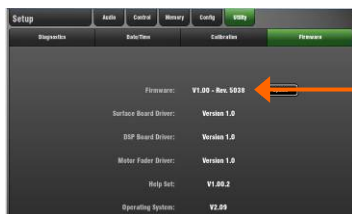

Go to the **Setup / Utility / Firmware** screen to check the current firmware version of running on the GLD. Go to www.allen-heath.com to check the latest version of GLD firmware available for download.

We recommend you check the Allen & Heath web site regularly and keep your console updated with the latest firmware.

Note 1: Use a USB key with at least **40 MB** of free space. Delete any existing GLD Firmware on the key as described below.

Note 2: The firmware **file transfer must not be interrupted**. Failure to complete the transfer may result in firmware corruption of the GLD. Make sure the mains power and connecting cables are reliable and that the system will not be disturbed or switched off during the update.

Note 3: **Updating firmware restores the console parameters to factory default**. If you want to keep your current settings then go to the **Setup / Memory / Show Manager** screen and store them as a **Show** memory before starting the update. Recall the show after you have updated your firmware.

Note 4: After updating the firmware you may need to **re-calibrate the touch screen and faders**. Do this using the **Setup / Utility / Calibration** screen.

Firmware update instructions for Windows:

Step1 Download the firmware

Visit www.allen-heath.com and download the latest GLD firmware. **Save** the zipped file to your Desktop or folder of your choice. You may also wish to keep a copy of this zip file as a backup of this version of firmware.

Step2 Remove any previous GLD Firmware from your USB key

Plug a USB key into your computer. If you have previous GLD firmware already on your key, look in its **AllenHeathGLD** folder and delete the existing **Firmware** directory and also the **Firmware.md5** file in the **AllenHeathGLD** folder. Do not delete the other directories.

Step3 Open and extract the Zip file to your USB key

Open up the zip file you have just downloaded. Extract all files to the **root** directory of your USB key. Once the extraction is complete check that a new **Firmware** directory has appeared under the **AllenHeathGLD** folder on your USB key. You may need to refresh the **AllenHeathGLD** folder to see this.

Note: Do not change the folder name or browse inside the **Firmware** folder as doing this may cause firmware corruption. Attempting to navigate or open files within this directory may cause your Operating System to leave behind temporary files which can invalidate your firmware.

Step4 Safely remove the USB key from your computer

Click on the 'safely remove hardware' icon, in the bottom right of your screen to safely remove your USB key.

Step5 Plug the key into a USB port on the GLD

Plug your USB key into either one of the USB ports on the GLD-80. Go to the **Setup / Utility / Firmware** screen and touch **Update**. This will then detect your USB key and validate the firmware contents.

Step6 Perform the update

Touch the **Update** button. **Do not interrupt this process**. When the firmware has been successfully installed, touch the **Reboot** button. The GLD will reboot with the new firmware installed. Any AudioRacks currently connected or connected later to the GLD-80 will have their firmware automatically updated by the GLD-80 during their boot process.

Step7 Recall your settings

Recall a Template Show or the User Show you saved before the update to restore your settings.

Firmware update instructions for Mac:

Step1 Download the firmware

Visit www.allen-heath.com and download the latest GLD firmware. **Save** the zipped file to your Desktop or folder of your choice. You may also wish to keep a copy of this zip file as a backup of this version of firmware.

Step2 Remove any previous GLD Firmware from your USB key

Plug a USB key into your computer. If you have previous GLD firmware already on your key, look in its [AllenHeathGLD](#) folder and delete the existing [Firmware](#) directory and also the [Firmware.md5](#) file in the [AllenHeathGLD](#) folder. Do not delete the other directories.

Step3 Extract the Zip file and copy the folder to your USB key

Navigate to where you have saved the GLD firmware zip file. Double click on the zip file to extract its contents (this may have automatically been done for you). You will now see a folder called [AllenHeathGLD](#). Copy this folder to the **root** directory of the USB key.

Check that a new [Firmware](#) directory has appeared under the [AllenHeathGLD](#) folder on your USB key. You may need to refresh the folder to see this.

Note: Do not change the folder name or browse inside the [Firmware](#) folder as doing this may cause firmware corruption. Attempting to navigate or open files within this directory may cause your Operating System to leave behind small temporary system files which can invalidate your firmware.

Step4 Eject the USB key from your computer

You can do this by clicking on the small eject icon by the USB key in Finder.

Step5 Plug the key into a USB port on the GLD

Plug your USB key into either one of the USB ports on the GLD-80. Go to the **Setup / Utility / Firmware** screen and touch **Update**. This will then detect your USB key and validate the firmware contents.

Step6 Perform the update

Touch the **Update** button. **Do not interrupt this process**. When the firmware has been successfully installed, touch the **Reboot** button. The GLD will reboot with the new firmware installed. Any AudioRacks currently connected or connected later to the GLD-80 will have their firmware automatically updated by the GLD-80 during their boot process.

Step7 Recall your settings

Recall a Template Show or the User Show you saved before the update to restore your settings.

USB directory structure

The AllenHeathGLD folder is located in the root directory of your USB key.

Event Logs are copied to this directory. You can email them to Allen & Heath Tech Support if they require further investigation.

Delete the **Firmware** directory as described in Step 2 above before unzipping a new version of firmware to your key. **Do not browse this directory** as opening files may result in the firmware failing to update.

The GLD uses these directories to store the parameter **Libraries** and User **Shows**.

GLD creates this folder when you open the **Setup / Audio / USB Audio** screen **Options** pull-up and choose the **'Show Playback Files'** option. Create this directory if it does not already exist and copy audio files from your computer here to view and play selected files rather than all audio on your USB key.

GLD creates this directory to store audio **recordings**.

Specification

Inputs	
XLR Mic/Line Inputs	Balanced, (All XLR on GLD-80 and AudioRacks)
Mic/Line Preamp	Fully recallable
Input Sensitivity	-60 to +15dBu
Analogue Gain	+5 to +60dB, 1dB steps
Pad	-20dB
Maximum Input Level	+32dBu
Input Impedance	>4kΩ (Pad out), >10kΩ (Pad in)
Mic/Line Channel noise	20-20kHz, Direct Out @ unbalanced out
Mic EIN	-127dB with 150Ω source
Unity gain (Pad in)	-90dBu
Low gain (5dB, Pad out)	-93dBu
Mid gain (30dB, Pad out)	-89dBu
Mic/Line Channel THD+N	20-20kHz, Direct Out @ unbalanced out
Unity gain (Pad in)	0.005% -86dBu @ 1kHz, 0dBu output
Low gain (5dB, Pad out)	0.003% -89dBu @ 1kHz, 0dBu output
Mid gain (30dB, Pad out)	0.004% -88dBu @ 1kHz, 0dBu output
RCA Line Inputs	Unbalanced (GLD-80)
Input Sensitivity	-24 to +24dBu, nominal 0dBu
Trim	+/-24dB, recallable
Maximum Input Level	+18dBu
Input Impedance	>10kΩ
RCA channel Noise	-92dBu 20-20kHz
RCA channel THD+N	0.0035% -90dBu @ 1kHz, 0dBu output
Outputs	
XLR Outputs	Balanced, Relay protected
Output Impedance	<75Ω
Nominal Output	+4dBu = 0dB meter reading
Maximum Output Level	+22dBu
Residual Output Noise	-91dBu (muted, 20-20kHz)
RCA Line Outputs	Balanced, Relay protected
Output Impedance	<75Ω
Nominal Output	0dBu = 0dB meter reading
Maximum Output Level	+18dBu
Residual Output Noise	-94dBu (muted, 20-20kHz)
Digital Outputs	48kHz sampling rate
SPDIF	RCA, 600mV, coax terminated input 75Ω
AES3 2 ch XLR output	XLR, 2.5Vpp balanced terminated 110 Ω
System	
Measured balanced XLR in to XLR out, 20-20kHz, minimum Gain, Pad out	
Dynamic Range	112dB
System Signal to Noise	-90dB
Frequency Response	0/-0.25dB @ 20Hz, 0/-0.5dB @ 20kHz
System peak level THD+N	0.0055% -68dBu @ +17dBu output, 1kHz
System Line level THD+ N	0.0022%, -84dBu @ +9dBu output, 1kHz
Headroom	+18dB
Internal operating Level	0dBu
dBFS Alignment	+18dBu = 0dBFS (+22dBu at XLR output)
Meter Calibration	0dB meter = -18dBFS (+4dBu at XLR out)
Meter Peak indication	-3dBFS (+19dBu at XLR out)
Meter Type	Fast (peak) response
Sampling Rate	48kHz +/-100PPM
ADC	24-bit Delta-Sigma
DAC	24-bit Delta-Sigma
Latency	1.49ms (GLD-80 local XLR in to XLR out) 0.68ms (GLD-80 local XLR in to digital out)
USB Playback	2 channel, WAV, FLAC 44.1/48kHz
USB Record	2 channel, 48kHz / 16bit - WAV
I/O Port	64 channel bi-directional
Card Options	A&H ACE, MADI, Dante, ES, Waves, MMO
Operating Temperature	0 deg C to 35 deg C (32 deg F to 95 deg F)

Control	
Touch Screen	8.4" TFT, 800x600 resolution
Faders	100mm motorised
GLD-80 Fader Strips	2 Banks (12,8), 4 Layers = 80x strips
GLD-112 Fader Strips	3 Banks (12,8,8), 4 Layers = 112x strips
Strip Display	LCD per strip, assignable backlight colours
SoftKeys	10 assignable
MIDI	MIDI In and Out
Network	TCP/IP Ethernet

FX Processing	
Internal FX	8x RackFX engine
Types	Reverbs, Delays, Modulators, Sub-harmonics, Pitch Shift, Rotary Speaker, De-Esser
Mode	Send>Return, Inserted, Daisy Chain FX
FX 'Short' Return Channels	
8 Stereo dedicated returns	Adds to inputs for up to 56 sources to the mix
Controls	Fader, Pan, Mute, Routing to Grp, Aux, FX, Main
FX Return PEQ	Same as Input Channel PEQ

Input Processing	
48 Processing Channels	Mono = 1-44, Stereo = 45/46, 47/48
Trim	+/-24dB digital trim
Polarity	Normal/Reverse
High Pass Filter	12dB/octave 20Hz – 2kHz
Insert	Assign to any sockets, In/Out, +4dBu/-10dBV level
Delay	Up to 85ms, Bypass switch Input global setting - ms, feet, meters, samples
Gate	
Sidechain	Self key, In/Out, Sel 'listen'
Sidechain Lo-Cut Filter	12dB/octave, Freq 20Hz – 5kHz
Sidechain Hi-Cut Filter	12dB/octave, Freq 120Hz – 20kHz
Threshold	-72dBu to +12dBu
Depth	0 to 60 dB
Attack	50us to 300ms
Hold	10ms to 5s
Release	10ms to 1s
PEQ	
Type	4-Band fully parametric, +/-15dB
Frequency Range	Global setting for Inputs = 20-20kHz or 'Analogue'
Analogue Ranges	20-200Hz, 35-1kHz, 500-15kHz, 2k-20kHz
Band 1	Selectable LF Shelving, Bell, Hi-Pass
Band 2	Bell
Band 3	Bell
Band 4	Selectable HF Shelving, Bell, Lo-Pass
Bell Width	Non-constant Q, variable, 1.5 to 1/9th octave
Shelving Type	Classic Baxandall
Hi-Pass, Lo-Pass Filter	12dB/octave
Compressor	
Sidechain	Self key, In/Out, Sel 'listen'
Sidechain Lo-Cut Filter	12dB/octave, Freq 20Hz – 5kHz
Sidechain Hi-Cut Filter	12dB/octave, Freq 120Hz – 20kHz
Threshold	-46dBu to 18dBu
Ratio	1:1 to infinity
Attack	300us – 300ms
Release	100ms – 2s
Knee	Soft/Hard
Manual Types	Peak Manual, RMS Manual
Auto Types	VocalAuto, OptoAuto, PunchBag
Channel Direct Out	Individual Trim (per channel)
Options	Source, follow Fader, follow Mute (global for all)

Mix Processing	
20 Mix Channels	Configure as mono/stereo Groups, Aux, Main, Matrix Mains = None, LR, LCR, LR+M(bus), LR+M(sum)
External Input	
Trim	Assignable source
Polarity	+/-24dB digital trim
	Normal/Reverse
Insert	
	Assign to any sockets, In/Out, +4dBu/-10dBV level
Delay	
	Up to 170ms, Bypass switch
	Mix global setting - ms, feet, meters, samples
GEQ	
Type	Constant 1/3 octave, 28 bands 31Hz -16kHz
Gain	+/-12dB
GEQ Fader Flip Mode	2 overlapping frequency banks on strip faders
	SEL key resets frequency band to 0dB
	RTA following PAFL is displayed on strip meters
PEQ	
Type	4-Band fully parametric, +/-15dB
Frequency Range	Global setting for Mixes = 20-20kHz or 'Analogue'
Analogue Ranges	20-200Hz, 35-1kHz, 500-15kHz, 2k-20kHz
Band 1	Selectable LF Shelving, Bell, Hi-Pass
Band 2	Bell
Band 3	Bell
Band 4	Selectable HF Shelving, Bell, Lo-Pass
Bell Width	Non-constant Q, variable, 1.5 to 1/9th octave
Shelving Type	Classic Baxandall
Hi-Pass, Lo-Pass Filter	12dB/octave
Compressor	
Sidechain	Self key, In/Out, Sel 'listen'
Sidechain Lo-Cut Filter	12dB/octave, Freq 20Hz - 5kHz
Sidechain Hi-Cut Filter	12dB/octave, Freq 120Hz - 20kHz
Threshold	-46dBu to 18dBu
Ratio	1:1 to infinity
Attack	300us - 300ms
Release	100ms - 2s
Knee	Soft/Hard
Manual Types	Peak Manual, RMS Manual
Auto Types	VocalAuto, OptoAuto, PunchBag
	filter in/out with sel 'listen'
Talkback	
Mode	Assignable source
High Pass Filter	Latched/Momentary, PAFL Dim option
Routing	12dB/octave, 20Hz-2kHz
Level Trim	To Groups, Aux, Main, Matrix
	+/-24dB
Signal Generator	
Sine, Bandpass sweep	Sine, White Noise, Pink Noise, Bandpass Noise
Controls	20-20kHz
Routing	Level, Mute
	To Groups, Aux, Main, Matrix
RTA	
Source	31-Bands 1/3 octave 20-20kHz
Peak Band Indication	Follows selected PAFL source
	Option to display dominant frequency

Dimensions and Weights	
GLD-80 Mixer	
Width x Depth x Height	
Unpacked	730 x 577 x 159mm (28.7" x 22.7" x 6.2")
Packed in shipping box	930 x 730 x 290mm (36.6" x 28.6" x 11.4")
Unpacked weight	16.5kg (36lbs)
Packed weight	21.2kg (46.6lbs)
GLD-112 Mixer	
Width x Depth x Height	
Unpacked	1000 x 577 x 159mm (39.4" x 22.7" x 6.2")
GLD-AR2412 AudioRack	
Width x Depth x Height	
Unpacked	483 x 220 x 137mm (19" x 8.6" x 5.4") 3U rack
Packed in shipping box	600 x 350 x 250mm (23.6" x 13.7" x 9.8")
Unpacked weight	5kg (11lbs)
Packed weight	6.4kg (14lbs)
GLD-AR2412 AudioRack	
Width x Depth x Height	
Unpacked	483 x 220 x 48mm (19" x 8.6" x 1.9") 1U rack
Packed in shipping box	600 x 330 x 143mm (23.6" x 12.9" x 5.6")
Unpacked weight	3kg (6.6lbs)
Packed weight	4.4kg (9.7lbs)
Mains Power	
GLD-80	100-240V AC, 50/60Hz, 95W max
GLD-112	100-240V AC, 50/60Hz, 110W max
GLD-AR2412	100-240V AC, 50/60Hz, 70W max
GLD-AR84	100-240V AC, 50/60Hz, 20W max

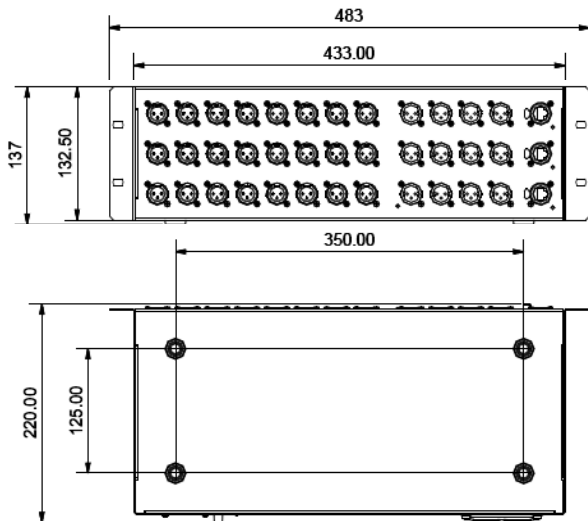
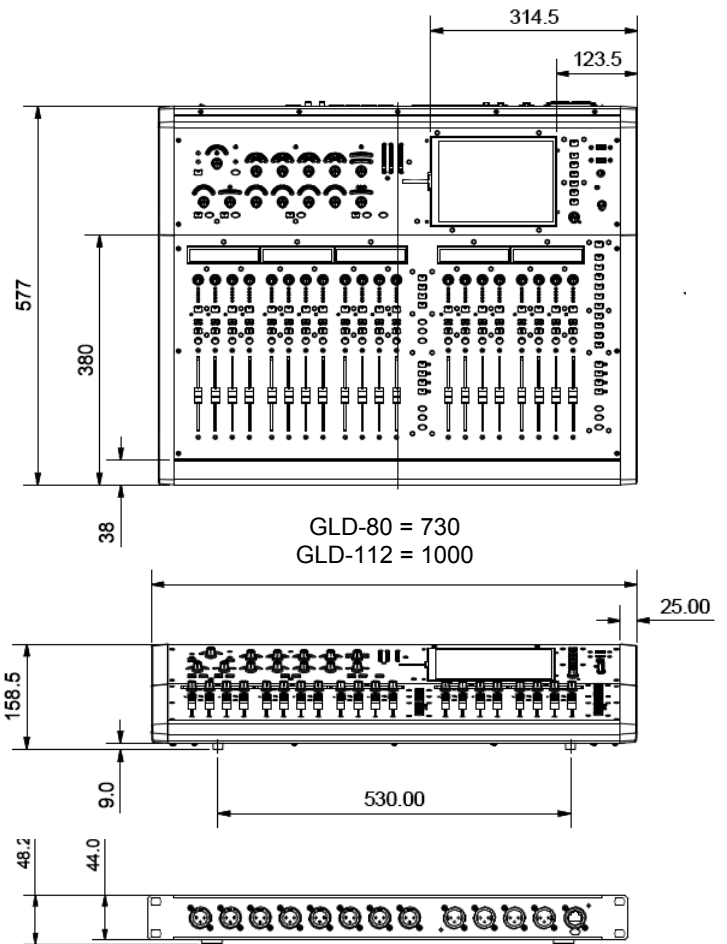
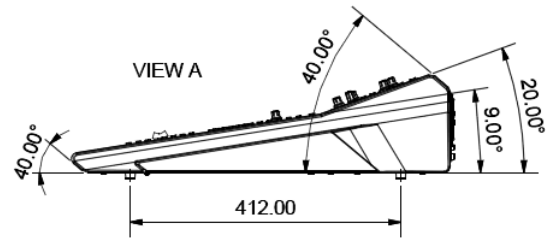

For the new user or guest engineer to start mixing with GLD. It assumes a mixer already configured for the show. To learn more about configuration, memories and advanced functions read the on-screen Help Manual and User Guide AP8561.

- 1** See where Input and Master **Faders** are by pressing Layer keys A,B,C,D and reading the displays

To change the strip assignments use the **Setup/Control** screen

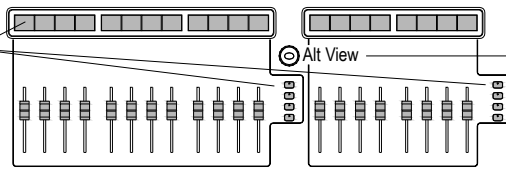

Press **Alt View** to view channel or socket numbers or fader dB value in place of Name. Set option in **Setup/Control** screen

- 2** See how the **Sockets** are patched using the **I/O** screen.

To change the socket assignments touch and select from drop-down menu

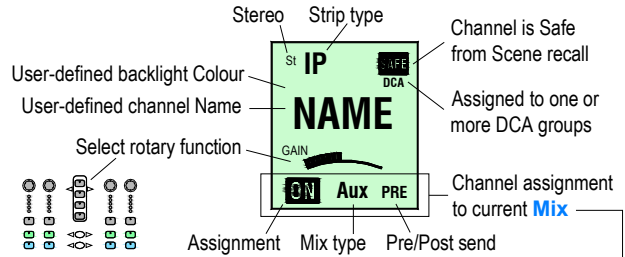
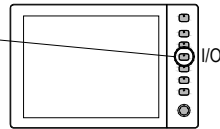

- 3** **Sel** Access the **Channel and Mix processing**

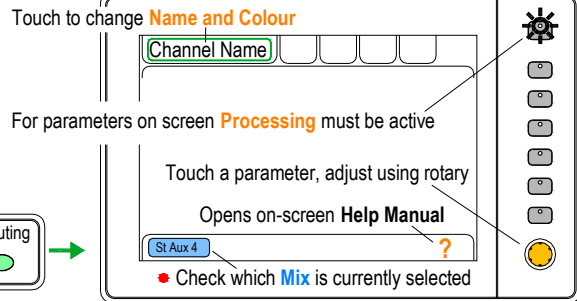
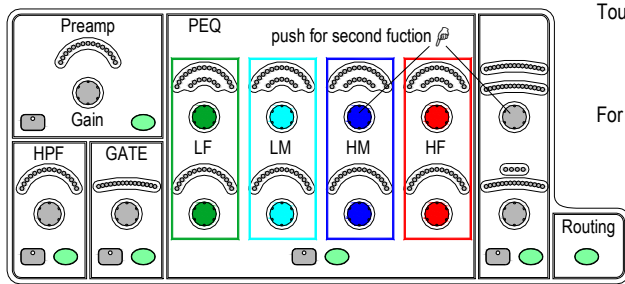

For GEQ on faders press **GEQ Fader Flip** - Master on last fader. RTA on strip meters. RTA follows current selected PAFL

- 4** **Mix** Access the **Sends and Assignments**

Normal mix mode (FOH)

Main **Mix** active

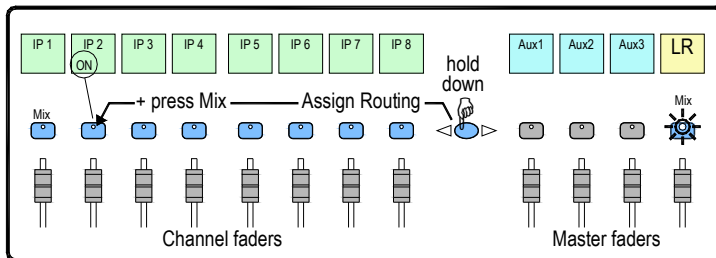

DCA and Audio Group assign

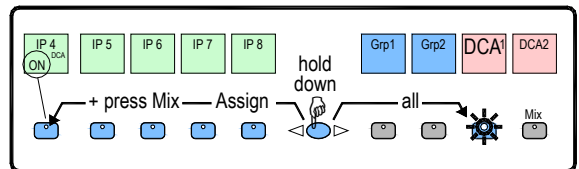

• Press **Mix** again to return to Main mix

Master **Mix** view

Access Aux, FX, Matrix mix on faders

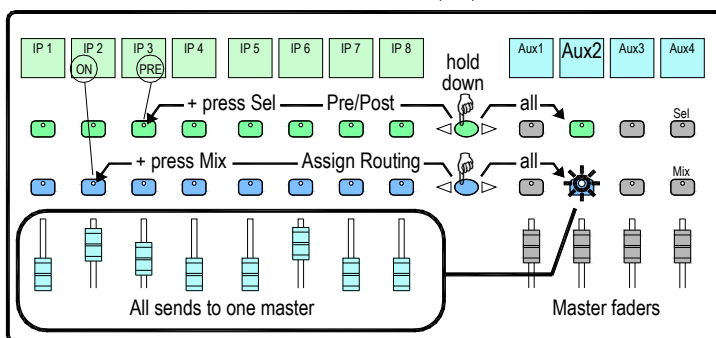

Channel **Mix** view

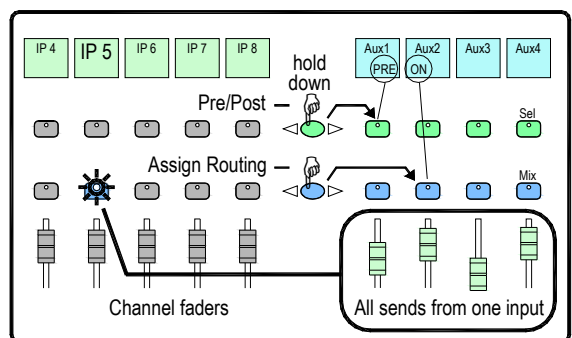

- 5** Access the **FX**
- > To send to an FX - press FX master **Mix**
 - > To adjust FX parameters - press FX strip **Sel**
 - > To return to the mix use related **FXret** channel

- 6** To **Link parameters** eg, 2 channels for stereo keyboard Use the **Ganging** screen. Choose attributes.
- Ganging does not link the Gains or Trims.

- 7** To **Copy parameters**

> Hold down **Copy** and press the **Sel** or **Mix** key of the parameters to copy:

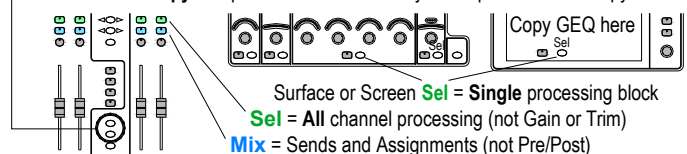

> Now hold down **Paste** and press the **Sel** or **Mix** key of the **strip** to paste to

